



ACCESSOIRES CATALOGUS

BOUW

20 juni 2023

 **ATTACHMENTS**

SET THE WORLD IN MOTION

De Manitou-groep werd meer dan 60 jaar geleden opgericht door de familie Braud en is nu over de hele wereld aanwezig. Als wereldleider op het gebied van het hanteren van ruw terrein ontwerpt, produceert, verdeelt en onderhoudt de groep uitrustingen voor de bouw, de landbouw en de industrie.

De productengamma's van het concern omvatten: vaste, roterende en zware verreikers voor ruw terrein, knikladers, ruwterrein-, semi-industriële en industriële masttrucks, schrankladers op wielen en rupsbanden, graaflaadmachines, hoogwerkers, on-board-trucks, magazijnuitrusting en aanbouwdelen.

Via zijn iconische merken, Manitou, Gehl, en zijn netwerk van 1.050 dealers wereldwijd, biedt de groep de beste oplossingen die de grootste waarde creëren voor zijn klanten.

De groep, met hoofdzetel in Frankrijk, realiseerde in 2021 een omzet van 1,9 miljard euro in 140 landen en stelt 4.500 mensen tewerk die resoluut focussen op klantentevredenheid.



2 merken

verdeeld door 1050 dealers in 140 landen



- 32 dochterondernemingen
- 10 productievestigingen
- 4500 werknemers wereldwijd
- 64% van de aandelen is in handen van de stichtende families
- 82% van de verkoop uit internationale markten
- 2021 omzet van 1,9 miljard euro



MANITOU is verheugd u deze nieuwe versie van zijn bijlagicatalogus voor te stellen. Het geeft u een volledig overzicht van het brede gamma goedgekeurde aanbouwdelen dat Manitou de markt voor zijn verreikers en vorkheftrucks.

Als fabrikant van verreikers en aanbouwdelen beschikt Manitou over de technische kennis, praktische ervaring en faciliteiten om elke combinatie van machine en aanbouwdeel te controleren en een perfecte efficiëntie te garanderen.

Manitou past een veeleisende interne procedure toe die leidt tot de goedkeuring van elk aanbouwdeel bij een machine. Deze unieke procedure garandeert veiligheid en een onovertroffen doeltreffendheid. Door een goedgekeurd Manitou-aanbouwdeel te kiezen en de beschreven compatibiliteit te respecteren, kunt u er zeker van zijn dat u het beste uit uw machine haalt, zonder in te boeten aan veiligheid en in overeenstemming met de Europese regelgeving.

Wij geloven dat u in deze catalogus alles zult vinden wat u nodig hebt. Hebt u iets nodig dat we nog niet aan ons aanbod hebben toegevoegd? Neem contact op met uw dichtstbijzijnde Manitou-dealer en onze afdeling voor speciale oplossingen kan u een oplossing op maat bieden voor uw behoeften.

Alle in dit document vermelde bevestigingscapaciteiten zijn nominale capaciteiten:

- De laadbakinhoud wordt berekend volgens ISO 7546: deze komt overeen met de volgens de norm berekende "koepelinhoud" in m³.
- De opgegeven grijperbakcapaciteiten zijn de totale capaciteit, gesloten grijper (in m³).
- De betonmixerbak, de rotorbak, de kiepbak en de kiepbak hebben een capaciteit in L en zijn berekend om een goede efficiëntie van alle functies te garanderen (watercapaciteit).
- De veegcapaciteiten zijn maximale vuilcapaciteiten.
- De capaciteit van de emmers wordt aangegeven in kg, inclusief 2 of 3 personen (afhankelijk van het type emmer).
- Alle andere capaciteiten zijn aangegeven in maximale veilige belasting.

Compatibiliteit

Met het oog op de leesbaarheid hebben wij de lijst van machines in deze gids vereenvoudigd. Deze moet als volgt gelezen worden:

- Alle compatibiliteiten worden gegeven voor de machines die aanwezig zijn in het aanbod van Manitou op de dag van uitgifte van de gids.
- Voor oudere machines kunt u contact opnemen met uw Manitou dealer.

Materiaaldichtheid gewicht

Materiaal	kg/m ³	Materiaal	kg/m ³
Appels	525	Mest (stalmest)	922
As	604	Nitraatmeststof	1250
Gerst	600	Haver	415
Bietenpulp (noten)	604	Uien	556
Bietenpulp (geperst)	906	Turf (droog)	400
Bierbostel	1110	Petroleumcokes	680
Baksteen toeslagmateriaal	1828	Aardappelen	699
Wortelen	636	Afval (stad)	318
Cement (natuurlijk)	874	Puin	1047
Cement (Portland)	1440	Zand (droog)	1550
Krijt	795	Zand (nat)	1890
Klei (fijn)	2080	Zaagsel	238
Klei (nat)	1680	Kuilvoer (kuilvoer)	747
Steenkool (antraciet)	1046	Kuilvoer (groen)	349
Steenkool (bitumineus)	765	Drijfmest	1780
Cokes (los)	570	Sneeuw (vers)	200
Aarde (droog)	1150	Sneeuw (nat)	400
Meststof (gemengd)	1030	Natriumchloride (droog zout)	1300
Meel	445	Stro (hoge dichtheid baal)	254
Grind (droog)	1650	Suikerbieten	530
Hooi (baal met normale dichtheid)	190	Rapen	540
limoen (snel)	881	Tarwe	730
Kalksteen (gemalen)	1530		

SAMENVATTING



BAKKEN
Bladzijde 9

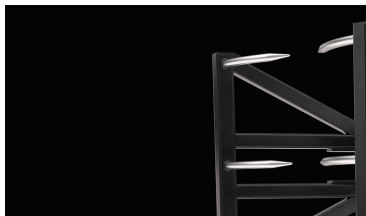

KLEMMEN
Bladzijde 68



VORKDRAGERS
Bladzijde 73



GIEKEN
Bladzijde 123

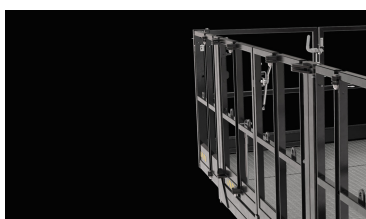

PLATFORMEN
Bladzijde 153



BETONSTORTBAKKEN
Bladzijde 190



VEEGMACHINES
Bladzijde 198

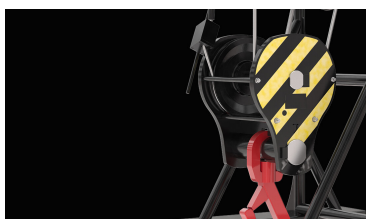

LIEREN
Bladzijde 212



MIJNBOUWACCESSOIRES
Bladzijde 221



EARTH DRILLING AND DIGGING SOLUTIONS
Bladzijde 228



SNOW REMOVING SOLUTIONS
Bladzijde 232

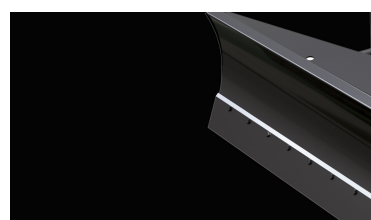



















LEVELLING SOLUTIONS
Bladzijde 239



DIVERSE VOORZETSTUKKEN
Bladzijde 246

INDEX

















BAKKEN

	10	4 in 1 bak
	14	4-in-1 bak (compacte machines)
	18	4-in-1 bak met tanden(compacte machines)
	22	Allroudbak (compacte machines)
	25	Betonmixbak
	27	Groot volumebak (compacte machines)
	31	Groot volumebak (MHT) NEW
	33	Groot volumebka met slijtmes (compacte machines)
	35	Light Material Bucket NEW
	37	Schepbak
	41	Schepbak
	44	Schepbak (MHT) NEW
	46	Schepbak (MRT) NEW
	48	Schepbak - Essentieel NEW
	52	Sloopbak met hoge weerstand (Compacte machines)
	55	Standaard graafbak (compacte machines)
	60	Standaard graafbak met tanden (compacte machines)
	65	Standaard graafbak met tanden en slijtmes (compacte machines)

KLEMMEN

	69	Balkenklem
--	----	------------

VORKDRAGERS

	74	360° Roterend vorkenbord
	76	Kantel- en zwenkbaar vorkenbord
	78	Palletvorken compleet (compacte machines)
	81	Rijtuig Drijvende Laadsteun En Vorken (MHT) NEW
	84	Rijtuig Drijvende Laadsteun En Vorken (MRT) NEW
	86	Rijtuig Drijvende Laadsteun En Vorken (MT - MLT) NEW
	90	Vast vorkenbord
	95	Vast vorkenbord (MRT - MHT) NEW
	98	Vast vorkenbord met sideshift (MLT - MT)
	101	Vast vorkenbord met sideshift (MRT - MHT) NEW
	103	Verstelbare vorkschort met load backplash (MLT - MT)
	106	Vlottend vorkenbord (MLT - MT)
	109	Vlottend vorkenbord met hydraulische schuinstelling
	111	Vlottend vorkenbord met sideshift (MLT - MT) NEW
	114	Vlottend vorkenbord met sideshift (MRT) NEW
	116	Vorkversteller voor vlottende vorken
	119	Zijdelingse kantelbare vorkdeur - Load backplash (MLT - MT)

GIEKEN

	124	Big bag handler
	128	draaibare jib
	130	Hijshaak voor zware lasten
	132	Jib met 2 haken
	135	Jib met 3 haken
	137	Op frame gemonteerd haak
	141	uitschuifbare jib
	144	Uitschuifbare Jib met lier
	146	Verlengde Jib
	149	Verlengde jib met lier

INDEX



PLATFORMEN

-  154 3D roterend pendelend platform
-  157 Aerial Jib 1
-  159 Aerial Jib 2
-  161 Aluminium werkkooi
-  163 Dakdekkers platform
-  166 Diep uitbreidbaar platform
-  168 Platform
-  172 Snel openende platform
-  177 Uitbreidbaar platform
-  180 Vast zwenkbare dakwerkerskooi
-  182 Verhoogd uitbreidbaar platform
-  184 Werkkooi met afneembaar FOPS dak
-  186 werkkooi met lier



EARTH DRILLING AND DIGGING SOLUTIONS

-  229 Hydraulische hamer (Compacte machines)

SNOW REMOVING SOLUTIONS

-  233 Sneeuwblazer (compacte machines)
-  235 Sneeuwschuiver (compacte machines)

LEVELLING SOLUTIONS

-  240 Hydr. Dozer blad (compacte machines)
-  243 Manueel Dozer blad (compacte machines)





DIVERSE VOORZETSTUKKEN

-  247 Mand materialen **NEW**



BETONSTORTBAKKEN

-  191 Betonkubel
-  194 Hijskubel



VEEGMACHINES

-  199 2-in-1 borstelmachine
-  202 borstelmachine met opvangbak
-  204 Hoge druk reiniger
-  206 Orienteerbare borstel (compacte machines)
-  208 Veegbak (compacte machines)

LIEREN

-  213 Hydraulische lier
-  216 Hydraulische lier voor zware lasten
-  218 Vario-lier

MIJNBOUWACCESSOIRES

-  222 Buizenklem
-  224 Tunnel werkkooi met FOPS dak

BAKKEN

Bereik

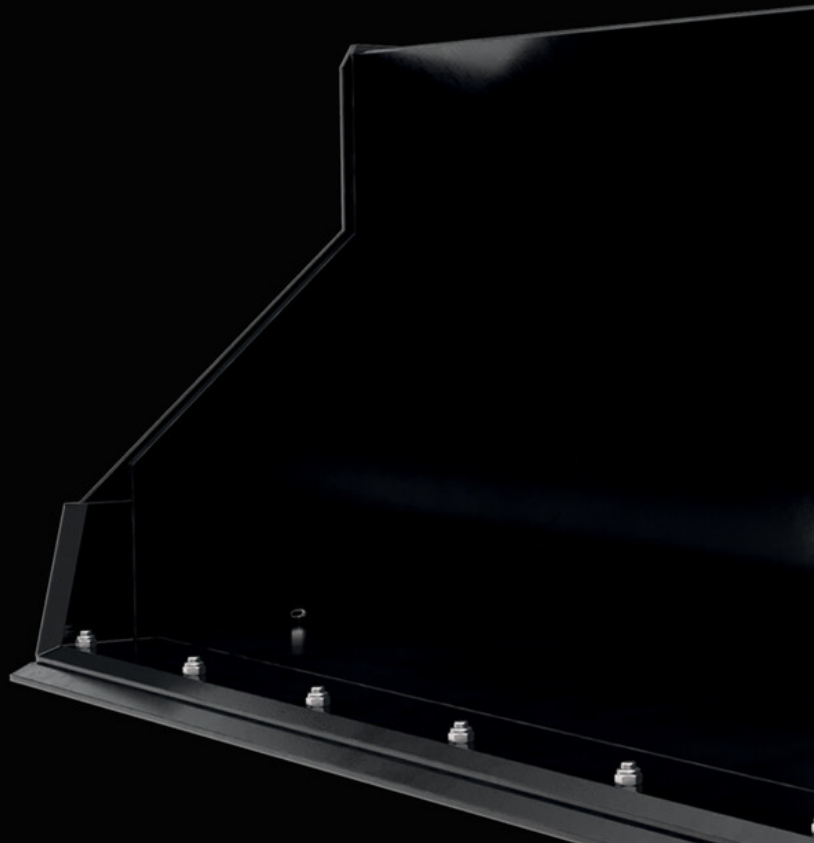

- 10 4 in 1 bak
- 14 4-in-1 bak (compacte machines)
- 18 4-in-1 bak met tanden(compacte machines)
- 22 Allroundbak (compacte machines)
- 25 Betonmixbak
- 27 Groot volumebak (compacte machines)
- 31 Groot volumebak (MHT) **NEW**
- 33 Groot volumebka met slijtmes (compacte machines)
- 35 Light Material Bucket **NEW**
- 37 Schepbak
- 41 Schepbak
- 44 Schepbak (MHT) **NEW**
- 46 Schepbak (MRT) **NEW**
- 48 Schepbak - Essentieel **NEW**
- 52 Sloopbak met hoge weerstand (Compacte machines)
- 55 Standaard graafbak (compacte machines)
- 60 Standaard graafbak met tanden (compacte machines)
- 65 Standaard graafbak met tanden en slijtmes (compacte machines)



4 IN 1 BAK



- 4 in 1 bak aangepast voor de verhandeling van materialen met een densiteit $\leq 2,1$.
- Geschroefd tegenmes achteraan om te niveleren.
- De klauwen aan de achterkant van het bewegende gedeelte helpen om cilindrische voorwerpen zoals palen, buizen, enz... te manipuleren.
- Versterkte structuur (basis, mes en zijkanten).
- Durable bucket designed for an intensive use: digging, soil or rubble handling applications.
- Specially created for building site and earthwork.
- Very rigid structure that ensures excellent bucket longevity.
- Bucket fitted with teeth made for an easy and powerful penetration on earth.



	B4x1 340 / 1500	CB4x1 400L / 1500	CB4x1 700L / 1950	CB4x1 850L / 2300	CB4x1 900L / 2450
Capaciteit (kg)	705	844	1470	1783	1888
Capaciteit van de koepel (l)	336	402	700	849	899
Slagcapaciteit (l)	263	313	524	628	672
Gewicht (kg)	341	535	608	682	714
Totale hoogte (mm)	855	899	890	890	890
Totale lengte (mm)	976	1106	1107	1107	1110
Breedte (mm)	1525	1525	1950	2300	2450
Machine-apparatuur	☐☐	☐☐	☐☐	☐☐	☐☐
Tanden	4	4	5	6	7

Machine compatibiliteit					
Referentienummer	-	52551750	751402	751401	751465
Referentienummer TSDL	-	-	-	52000367	52000368
Referentievorkbord schranklader	52707200	52000785	-	-	-
4 point Carriage	52742064	-	-	-	-
Euro Carriage	52742065	-	-	-	-
GCT 3-14	X	-	-	-	-
GCT 3-14 +	X	-	-	-	-
MLT 420-60 H	-	X	-	-	-
MLT 625-75 H	-	-	X	-	-
MLT 635-130 PS+	-	-	-	-	X
MLT 635-140 V+	-	-	-	-	X
MLT 733-115	-	-	-	-	X
MLT 733-115 LSU	-	-	-	-	X
MLT 737-130 PS+	-	-	-	-	X
MLT 741-130 PS+	-	-	-	-	X
MLT 741-140 V+	-	-	-	-	X
MLT 841-145 PS+	-	-	-	-	X
MLT 850-145 V+	-	-	-	-	X
MLT 940-140 V+	-	-	-	-	X
MLT 1041-145 PS+L	-	-	-	-	X
MLT-X 625-75 H	-	-	X	-	-
MLT-X 735 T LSU	-	-	-	-	X
MLT-X 737-130 PS+	-	-	-	-	X
MLT-X 741-140 V+	-	-	-	-	X
MLT-X 841 - 145 PS+	-	-	-	-	X
MLT-X 850-145 V+	-	-	-	-	X
MLT-X 1041-145 PS+L	-	-	-	-	X
MT 420 H	-	X	-	-	-
MT 625 e	-	-	X	-	-
MT 625 HA	-	-	X	-	-
MT 730 H	-	-	X	-	-
MT 733 Easy	-	-	-	-	X
MT 735 75D ST5	-	-	-	X	X
MT 930 H	-	-	X	-	-
MT 930 HA	-	-	X	-	-

B4x1 340 / 1500	CB4x1 400L / 1500	CB4x1 700L / 1950	CB4x1 850L / 2300	CB4x1 900L / 2450
-----------------	-------------------	-------------------	-------------------	-------------------

Machine compatibiliteit				
MT 933 Easy	-	-	-	X
MT 935 75D ST5	-	-	X	X
MT 1033 easy	-	-	-	X
MT 1135 75 D	-	-	X	X
MT 1135 H 100D	-	-	X	X
MT 1135 easy ST5	-	-	-	X
MT 1135 H easy ST5	-	-	-	X
MT 1135 HA Easy ST5	-	-	-	X
MT 1135 ST5	-	-	-	X
MT 1335 75D ST5	-	-	X	X
MT 1335 100D ST5	-	-	X	X
MT 1335	-	-	-	X
MT 1335 easy ST5	-	-	-	X
MT 1335 H 75D ST5	-	-	X	X
MT 1335 H 100D ST5	-	-	X	X
MT 1335 H easy ST5	-	-	-	X
MT 1335 HA 75D ST5	-	-	X	X
MT 1335 HA 100D ST5	-	-	X	X
MT 1335 HA easy ST5	-	-	-	X
MT 1335 ST5	-	-	-	X
MT 1440 A	-	-	X	X
MT 1440 A ST5	-	-	X	X
MT 1440 easy ST5	-	-	X	X
MT 1440 HA	-	-	X	X
MT 1440 HA ST5	-	-	X	X
MT 1440 ST5	-	-	X	X
MT 1840 A 100D ST5 S1	-	-	X	X
MT 1840 A	-	-	X	X
MT 1840 easy ST5	-	-	X	X
MT 1840 HA	-	-	X	X
MT 1840 HA	-	-	X	X
MT 1840 ST5	-	-	X	X
MT-X 420 H	-	X	-	-
MT-X 625 H	-	-	X	-
MT-X 733	-	-	-	X
MT-X 1033	-	-	-	X
MT-X 1440	-	-	X	X
MT-X 1440 A	-	-	X	X
MT-X 1840	-	-	X	X
MT-X 1840 A	-	-	X	X
MXT 840 K	-	-	-	X
MXT 840 P	-	-	-	X
MXT 1740 K	-	-	-	X
MXT 1740 P	-	-	-	X

B4x1 340 / 1500	CB4x1 400L / 1500	CB4x1 700L / 1950	CB4x1 850L / 2300	CB4x1 900L / 2450
-----------------	-------------------	-------------------	-------------------	-------------------

Machine compatibiliteit					
RS 4-14 Gen: 3	-	X	-	-	-
ULM 412 H	X	-	-	-	-
ULM 412 H	X	-	-	-	-
ULM 415 H	X	-	-	-	-
ULM 415 H	X	-	-	-	-







VERPLICHTE UITRUSTING VAN MACHINES : 



4-IN-1 BAK (COMPACTE MACHINES)









- Verhoogde bescherming van de componenten.
- Draagbladen en versterkingen in 400 HB staal voor extra sterkte.
- Ontworpen voor alle bouwtoepassingen.
- Veelzijdige gebruik om bulkmaterialen te beheren, om te duwen, vast te grijpen, enz...

	B4x1 920 / 170	B4x1 1080 / 210	B4x1 1380 / 300	B4x1 1520 / 330	B4x1 1550 / 340	B4x1 1650 / 610	B4x1 1680 / 370
Capaciteit van de koepel (l)	170	210	300	330	340	610	370
Gewicht (kg)	170	180	250	253	260	470	328
Totale hoogte (mm)	713	713	721	721	721	863	721
Breedte (mm)	920	1080	1380	1520	1550	1650	1680
Diepte (mm)	671	671	730	730	730	833	730
Machine-apparatuur							
Flexibele buis	Nee	Nee	Nee	Nee	Nee	Nee	Nee







Machine compatibiliteit							
All-Tach® Narrow	N004044	-	-	-	-	-	-
All-Tach®	N726014	N726016	N736018	N736019	N736067	N51502529	N747018
4 point Carriage	N51502389	-	-	-	-	N51502589	-
Euro Carriage	-	-	-	-	-	N51502548	-
850 R	X	X	-	-	-	-	-
1050 R	-	-	X	-	-	-	-
1050 RT	-	-	X	-	-	-	-
1350 R NXT2	-	-	X	X	X	-	-
1350 RT	-	-	X	X	X	-	-
1640 E	X	X	-	-	-	-	-
1650 R	-	-	-	-	-	-	X
1650 RT	-	-	-	-	X	-	X
1900 R	-	-	-	-	-	-	X
2100V	-	-	-	-	-	-	X
AL650	-	-	-	-	-	X	-
AL750	-	-	-	-	-	X	-
MLA 6-65 H-Z	-	-	-	-	-	X	-
MLA 7-75 H-Z	-	-	-	-	-	X	-
R105	-	-	X	-	-	-	-
R135	-	-	X	X	-	-	-
R165	-	-	-	-	-	-	X
R190	-	-	-	-	-	-	X
RT105	-	-	X	-	-	-	-
RT135	-	-	X	X	X	-	-
RT165	-	-	-	-	X	-	X
V210 - NEW	-	-	-	-	-	-	X

VERPLICHTE UITRUSTING VAN MACHINES : 

	B4x1 1680 / 430	B4x1 1760 / 420	B4x1 1760 / 450	B4x1 1800 / 670	B4x1 1830 / 450 (a)	B4x1 1830 / 450 (b)
Capaciteit van de koepel (l)	430	420	450	670	450	450
Gewicht (kg)	350	385	410	500	420	420
Totale hoogte (mm)	767	767	767	863	767	767
Breedte (mm)	1680	1760	1760	1800	1830	1830
Diepte (mm)	786	800	786	833	880	800
Machine-apparatuur						
Flexibele buis	Nee	Nee	Nee	Nee	Nee	Nee

Machine compatibiliteit						
All-Tach® Narrow	-	-	-	-	-	-
All-Tach®	N51502041	N51502476	N51502042	N51502528	N757024	N51502478
4 point Carriage	-	-	-	N51502591	-	-
Euro Carriage	-	-	-	N51502550	-	-
1850 RT	X	-	X	-	-	-
2100VT	X	-	X	-	-	-
2200 R	-	X	-	-	-	X
2300V	-	X	-	-	-	X
2600 R	-	-	-	-	-	X
2700 V NXT:2	-	-	-	-	X	-
2750V	-	X	-	-	X	X
3300 V NXT:2	-	-	-	-	X	-
AL650	-	-	-	X	-	-
AL750	-	-	-	X	-	-
MLA 6-65 H-Z	-	-	-	X	-	-
MLA 7-75 H-Z	-	-	-	X	-	-
R220	-	X	-	-	-	X
R260	-	-	-	-	-	X
RT185	X	-	X	-	-	-
V230 - NEW	-	X	-	-	-	X
V270	-	-	-	-	X	-
V275 - NEW	-	X	-	-	X	X
V330	-	-	-	-	X	-
VT210 - NEW	X	-	X	-	-	-

VERPLICHTE UITRUSTING VAN MACHINES : 

	B4x1 1850 / 480	B4x1 1880 / 480	B4x1 1950 / 720	B4x1 2140 / 560 (a)	B4x1 2140 / 560 (b)	B4x1 2150 / 800
Capaciteit van de koepel (l)	480	480	720	560	560	820
Gewicht (kg)	420	420	525	475	475	565
Totale hoogte (mm)	767	767	863	767	767	863
Breedte (mm)	1850	1880	1950	2140	2140	2150
Diepte (mm)	786	786	833	786	786	833
Machine-apparatuur						
Flexibele buis	Nee	Nee	Nee	Nee	Nee	Nee

Machine compatibiliteit						
All-Tach® Narrow	-	-	-	-	-	-
All-Tach®	N51502043	N51502082	N51502527	N700255	N51502044	N51502526
4 point Carriage	-	-	N51502593	-	-	N51502595
Euro Carriage	-	-	N51502552	-	-	N51502554
1850 RT	X	-	-	-	-	-
2100V	-	X	-	-	-	-
2100VT	X	-	-	-	-	-
2150 RT	X	-	-	-	X	-
2200 R	-	X	-	-	-	-
2300V	-	X	-	-	-	-
2600 R	-	X	-	-	-	-
2700 V NXT:2	-	X	-	-	-	-
2750V	-	X	-	-	-	-
2750VT	-	-	-	-	X	-
3300 V NXT:2	-	X	-	X	-	-
4200 V	-	X	-	X	-	-
AL650	-	-	X	-	-	X
AL750	-	-	X	-	-	X
MLA 6-65 H-Z	-	-	X	-	-	X
MLA 7-75 H-Z	-	-	X	-	-	X
R220	-	X	-	-	-	-
R260	-	X	-	-	-	-
RT185	X	-	-	-	-	-
RT215	X	-	-	-	X	-
V210 - NEW	-	X	-	-	-	-
V230 - NEW	-	X	-	-	-	-
V270	-	X	-	-	-	-
V275 - NEW	-	X	-	-	-	-
V330	-	X	-	X	-	-
VT210 - NEW	X	-	-	-	-	-
VT275 - NEW	-	-	-	-	X	-







VERPLICHTE UITRUSTING VAN MACHINES : 



4-IN-1 BAK MET TANDEN(COMPACTE MACHINES)









- Vastgeboute HD-tanden voor een betere graafefficiëntie.
- Draagbladen en versterkingen in 400 HB staal voor extra sterkte.
- Ontworpen voor alle bouwtoepassingen.
- Veelzijdige gebruik om bulkmaterialen te beheren, om te duwen, vast te grijpen, enz...

	B4x1 920 / 170 T (a)	B4x1 1080 / 210 T	B4x1 1380 / 270 T	B4x1 1380 / 300 T	B4x1 1520 / 330 T	B4x1 1550 / 340 T	B4x1 1650 / 610 T
Capaciteit van de koepel (l)	170	210	270	300	330	340	610
Gewicht (kg)	175	180	219	250	253	260	482
Totale hoogte (mm)	713	713	713	721	721	721	863
Breedte (mm)	920	1080	1380	1380	1520	1550	1650
Diepte (mm)	870	671	870	730	730	730	933
Machine-apparatuur							
Tanden	5	6	7	7	7	7	8
Flexibele buis	Nee	Nee	Nee	Nee	Nee	Nee	Nee

Machine compatibiliteit							
All-Tach® Narrow	N004068	-	N004070	-	-	-	-
All-Tach®	N726015	N726017	-	N736020	N736021	N736068	N51502525
4 point Carriage	N51502392	-	N51502394	-	-	-	N51502590
Euro Carriage	-	-	N51502137	-	-	-	N51502549
850 R	X	X	-	-	-	-	-
1050 R	-	-	-	X	-	-	-
1050 RT	-	-	-	X	-	-	-
1350 R NXT2	-	-	-	X	X	X	-
1350 RT	-	-	-	X	X	X	-
1640 E	X	X	-	-	-	-	-
1650 RT	-	-	-	-	-	X	-
AL230	-	-	X	-	-	-	-
AL320	-	-	X	-	-	-	-
AL330	-	-	X	-	-	-	-
AL420	-	-	X	-	-	-	-
AL430	-	-	X	-	-	-	-
AL650	-	-	-	-	-	-	X
AL750	-	-	-	-	-	-	X
MLA 2-25 H	-	-	X	-	-	-	-
MLA 3-25 H	-	-	X	-	-	-	-
MLA 3-25 H-C	-	-	X	-	-	-	-
MLA 4-50 H	-	-	X	-	-	-	-
MLA 4-50 H-C	-	-	X	-	-	-	-
MLA 6-65 H-Z	-	-	-	-	-	-	X
MLA 7-75 H-Z	-	-	-	-	-	-	X
R105	-	-	-	X	-	-	-
R135	-	-	-	X	-	X	-
RT105	-	-	-	X	-	-	-
RT135	-	-	-	X	X	X	-
RT165	-	-	-	-	-	X	-













VERPLICHTE UITRUSTING VAN MACHINES : 

	B4x1 1680 / 370 T	B4x1 1680 / 430 T	B4x1 1760 / 420 T	B4x1 1760 / 450 T	B4x1 1800 / 670 T	B4x1 1830 / 450 T (a)	B4x1 1830 / 450 T (b)
Capaciteit van de koepel (l)	370	430	420	450	670	450	450
Gewicht (kg)	328	350	385	410	514	420	420
Totale hoogte (mm)	721	767	767	767	863	767	767
Breedte (mm)	1680	1680	1760	1760	1800	1830	1830
Diepte (mm)	730	786	800	786	933	800	800
Machine-apparatuur							
Tanden	8	8	8	8	9	9	9
Flexibele buis	Nee	Nee	Nee	Nee	Nee	Nee	Nee

Machine compatibiliteit

All-Tach® Narrow	-	-	-	-	-	-	-
All-Tach®	N747019	N51502045	N51502477	N51502046	N51502524	N757025	N51502479
4 point Carriage	-	-	-	-	N51502592	-	-
Euro Carriage	-	-	-	-	N51502551	-	-
1650 R	X	-	-	-	-	-	-
1650 RT	X	-	-	-	-	-	-
1850 RT	-	X	-	X	-	-	-
1900 R	X	-	-	-	-	-	-
2100V	X	-	-	-	-	-	X
2100VT	-	X	-	X	-	-	-
2200 R	-	-	X	-	-	-	X
2300V	-	-	X	-	-	-	X
2600 R	-	-	-	-	-	-	X
2700 V NXT:2	-	-	-	-	-	X	-
2750V	-	-	X	-	-	X	X
3300 V NXT:2	-	-	-	-	-	X	-
AL650	-	-	-	-	X	-	-
AL750	-	-	-	-	X	-	-
MLA 6-65 H-Z	-	-	-	-	X	-	-
MLA 7-75 H-Z	-	-	-	-	X	-	-
R165	X	-	-	-	-	-	-
R190	X	-	-	-	-	-	-
R220	-	-	X	-	-	-	X
R260	-	-	-	-	-	-	X
RT165	X	-	-	-	-	-	-
RT185	-	X	-	X	-	-	-
V210 - NEW	X	-	-	-	-	-	X
V230 - NEW	-	-	X	-	-	-	X
V270	-	-	-	-	-	X	-
V275 - NEW	-	-	X	-	-	X	X
V330	-	-	-	-	-	X	-
VT210 - NEW	-	X	-	X	-	-	-

VERPLICHTE UITRUSTING VAN MACHINES : 

	B4x1 1850 / 480 T	B4x1 1880 / 480 T	B4x1 1950 / 720 T	B4x1 2140 / 560 T (a)	B4x1 2140 / 560 T (b)	B4x1 2150 / 800 T
Capaciteit van de koepel (l)	480	480	720	560	560	820
Gewicht (kg)	420	420	540	475	475	572
Totale hoogte (mm)	767	767	863	767	767	863
Breedte (mm)	1850	1880	1950	2140	2140	2150
Diepte (mm)	786	786	933	786	786	933
Machine-apparatuur	 	 	 	 	 	 
Tanden	9	9	10	11	11	11
Flexibele buis	Nee	Nee	Nee	Nee	Nee	Nee

Machine compatibiliteit						
All-Tach® Narrow	-	-	-	-	-	-
All-Tach®	N51502047	N51502083	N51502523	N700256	N51502048	N51502522
4 point Carriage	-	-	N51502594	-	-	N51502596
Euro Carriage	-	-	N51502553	-	-	N51502555
1850 RT	X	-	-	-	-	-
2100VT	X	-	-	-	-	-
2150 RT	X	-	-	-	X	-
2200 R	-	X	-	-	-	-
2300VT	X	-	-	-	-	-
2600 R	-	X	-	-	-	-
2700 V NXT:2	-	X	-	-	-	-
2750VT	-	-	-	-	X	-
3300 V NXT:2	-	X	-	X	-	-
4200 V	-	-	-	X	-	-
AL650	-	-	X	-	-	-
AL750	-	-	X	-	-	X
MLA 6-65 H-Z	-	-	X	-	-	-
MLA 7-75 H-Z	-	-	X	-	-	X
R220	-	X	-	-	-	-
R260	-	X	-	-	-	-
RT185	X	-	-	-	-	-
RT215	X	-	-	-	X	-
V270	-	X	-	-	-	-
V330	-	X	-	X	-	-
VT210 - NEW	X	-	-	-	-	-
VT230 - NEW	X	-	-	-	-	-
VT275 - NEW	-	-	-	-	X	-

VERPLICHTE UITRUSTING VAN MACHINES : 



ALLROUNDBAK (COMPACTE MACHINES)

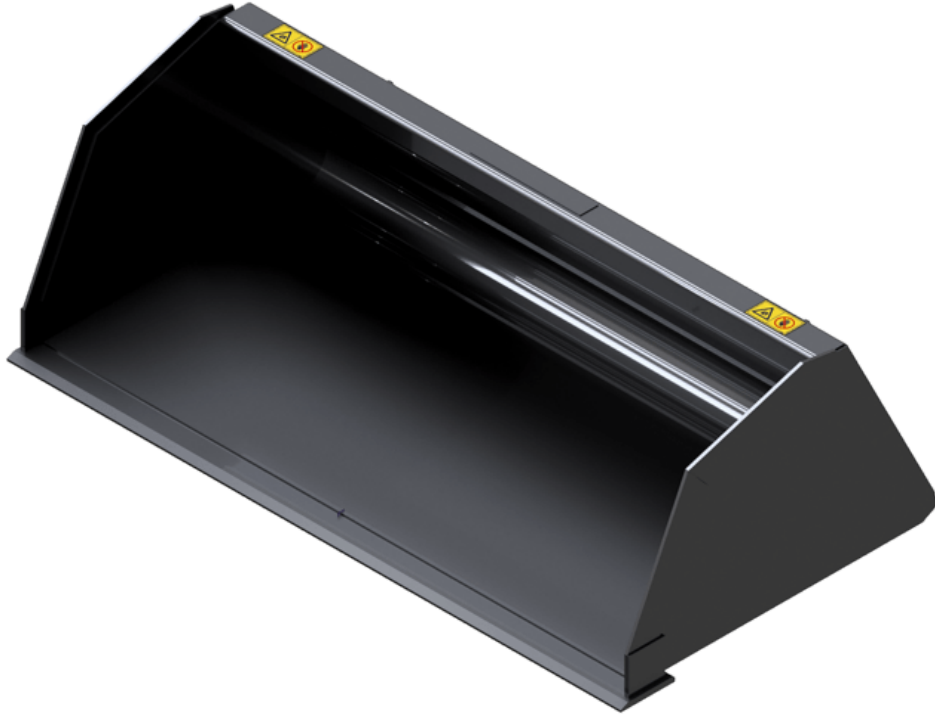

- Hogere capaciteit voor materialen met gemiddelde dichtheid ($< 1,5$ t/m³).
- Robuust gebouwd voor intensieve laadtoepassingen.
- Slijtstuk en zijdelingse slijtstrippen in 400 HB.
- Veelzijdige bak, bijzonder interessant voor verhuurtoepassingen.

	BU 920 / 210	BU 1080 / 250	BU 1380 / 380	BU 1520 / 430	BU 1680 / 590	BU 1680 / 790	BU 1760 / 690	BU 1760 / 740
Capaciteit (kg)	315	375	570	645	885	1185	1035	1110
Capaciteit van de koepel (l)	210	250	380	430	590	790	690	740
Gewicht (kg)	58	60	146	-	250	-	255	210
Totale hoogte (mm)	463	463	524	524	572	732	645	670
Breedte (mm)	920	1080	1380	1520	1680	1680	1760	1760
Diepte (mm)	889	889	889	889	948	1055	952	960
Machine-apparatuur	×	×	×	×	×	×	×	×
Flexibele buis	Nee	Nee	Nee	-	Nee	-	Nee	Nee

Machine compatibiliteit								
All-Tach®	N726006	N726007	N736011	N736012	N747008	N51502033	N757009	N51502466
850 R	X	X	-	-	-	-	-	-
1050 R	-	-	X	-	-	-	-	-
1050 RT	-	-	X	-	-	-	-	-
1350 R NXT2	-	-	X	X	X	-	-	-
1350 RT	-	-	X	X	X	-	-	-
1640 E	X	X	-	-	-	-	-	-
1650 R	-	-	-	-	X	-	X	-
1650 RT	-	-	-	-	X	-	X	-
1850 RT	-	-	-	-	-	X	-	-
1900 R	-	-	-	-	X	-	-	X
2100V	-	-	-	-	X	-	-	-
2200 R	-	-	-	-	-	-	-	X
2300V	-	-	-	-	-	-	X	X
2700 V NXT:2	-	-	-	-	-	-	X	-
2750V	-	-	-	-	-	-	X	X
R105	-	-	X	-	-	-	-	-
R135	-	-	X	X	X	-	-	-
R165	-	-	-	-	X	-	X	-
R190	-	-	-	-	X	-	-	X
R220	-	-	-	-	-	-	-	X
RT105	-	-	X	-	-	-	-	-
RT135	-	-	X	X	X	-	-	-
RT165	-	-	-	-	X	-	X	-
RT185	-	-	-	-	-	X	-	-
V210 - NEW	-	-	-	-	X	-	-	-
V230 - NEW	-	-	-	-	-	-	X	X
V270	-	-	-	-	-	-	X	-
V275 - NEW	-	-	-	-	-	-	X	X

VERPLICHTE UITRUSTING VAN MACHINES : ×

	BU 1760 / 830	BU 1830 / 720	BU 1830 / 780	BU 1850 / 900	BU 1880 / 900	BU 2080 / 1010	BU 2140 / 1050 (a)	BU 2140 / 1050 (b)
Capaciteit (kg)	1245	1080	1170	1350	1350	1515	1575	1575
Capaciteit van de koepel (l)	830	720	780	900	900	1010	1050	1050
Gewicht (kg)	-	260	225	-	360	370	378	378
Totale hoogte (mm)	732	645	670	732	732	732	732	732
Breedte (mm)	1760	1830	1830	1850	1880	2080	2140	2140
Diepte (mm)	1055	952	960	1055	1055	1055	1055	1055
Machine-apparatuur	×	×	×	×	×	×	×	×
Flexibele buis	-	Nee	Nee	-	Nee	Nee	Nee	Nee

Machine compatibiliteit								
All-Tach®	N51502034	N757010	N51502467	N51502035	N51502074	N51502075	N700247	N51502036
1850 RT	X	-	-	X	-	-	-	-
2100VT	X	-	-	X	-	X	-	-
2150 RT	-	-	-	X	-	-	-	X
2200 R	-	-	X	-	-	-	-	-
2300VT	-	-	-	X	-	-	-	-
2600 R	-	-	X	-	X	-	-	-
2700 V NXT:2	-	X	-	-	-	-	-	-
2750V	-	-	-	-	X	X	-	-
2750VT	-	-	-	-	-	-	-	X
3300 V NXT:2	-	-	-	-	X	X	X	-
4200 V	-	-	-	-	-	X	X	-
R220	-	-	X	-	-	-	-	-
R260	-	-	X	-	X	-	-	-
RT185	X	-	-	X	-	-	-	-
RT215	-	-	-	X	-	-	-	X
V270	-	X	-	-	-	-	-	-
V275 - NEW	-	-	-	-	X	X	-	-
V330	-	-	-	-	X	X	X	-
VT210 - NEW	X	-	-	X	-	X	-	-
VT230 - NEW	-	-	-	X	-	-	-	-
VT275 - NEW	-	-	-	-	-	-	-	X

VERPLICHTE UITRUSTING VAN MACHINES : ✕



BETONMIXBAK



- Capaciteit 500 L en 750 L.
- Vastgeboute mengpalen uit anti-abrasief staal.
- Standaard met elektrische oproller.
- Afvoergoot 1.5 m (standaard) voor een gelijkmatige verdeling.
- Zijdelingse verdeling met hydraulische bediening, voor een maximale veiligheid van de gebruikers.
- Doeltreffend werktuig ontworpen voor intensief gebruik.
- Mengeling klaar in minder dan 3 minuten.
- Beschermrooster uitgerust met een zakopener.
- Voldoet voor droge mengelingen.
- Verwisselbare mengschoppen voor een economisch gebruik.
- Dubbele betonstroom: mogelijkheid om langer te mengen zonder dat de mengeling van mengrichting hoeft te veranderen.



	BMC 500
Capaciteit (kg)	1050
Capaciteit van de koepel (l)	500
Gewicht (kg)	650
Totale hoogte (mm)	1120
Totale lengte (mm)	1130
Breedte (mm)	1750
Machine-apparatuur	
Flexibele buis	Ja

Machine compatibiliteit

Referentienummer	757637
MRT 2260 e	X
MRT 2660 e	X
MT 1135 easy ST5	X
MT 1135 H easy ST5	X
MT 1335	X
MT 1335 H easy ST5	X
MT 1440 A	X
MT 1440 HA	X
MT 1840 A	X
MT 1840 easy ST5	X
MT 1840 HA	X
MT-X 1440	X
MT-X 1440 A	X
MT-X 1840	X
MT-X 1840 A	X

VERPLICHTE UITRUSTING VAN MACHINES : 



GROOT VOLUMEBAK (COMPACTE MACHINES)



- Bestemd voor vrac materialen met een dichtheid <math>< 1\text{t/m}^3</math>.
- LSlijtmessen 400 HB voor een grotere slijtvastheid.
- Breed gamma bakken van verschillende capaciteiten.
- Grotere capaciteiten voor doeltreffende laadtoepassingen.

	BLM 920 / 240	BLM 1080 / 290	BLM 1220 / 330	BLM 1300 / 630 (c)	BLM 1380 / 430	BLM 1400 / 680 (b)	BLM 1400 / 680 (c)	BLM 1500 / 730 (c)
Capaciteit (kg)	240	290	330	630	430	680	680	730
Capaciteit van de koepel (l)	240	290	330	630	430	680	680	730
Gewicht (kg)	62	67	-	205	140	210	210	220
Totale hoogte (mm)	490	490	490	795	600	775	795	795
Breedte (mm)	920	1080	1220	1300	1380	1400	1400	1500
Diepte (mm)	819	819	819	957	890	988	967	951
Machine-apparatuur	×	×	×	×	×	×	×	×
Flexibele buis	Nee	Nee	-	Nee	Nee	Nee	Nee	Nee

Machine compatibiliteit								
All-Tach®	N726009	N726010	N726011	N004092	N736013	N004089	N004093	N004094
4 point Carriage	-	-	-	N003092	-	52799520	N003093	N003094
Euro Carriage	-	-	-	N51502185	-	N51502161	N51502186	N51502187
850 R	X	X	-	-	-	-	-	-
1050 R	-	-	X	-	X	-	-	-
1050 RT	-	-	X	-	X	-	-	-
1350 R NXT2	-	-	X	-	X	-	-	-
1350 RT	-	-	X	-	X	-	-	-
1640 E	X	X	-	-	-	-	-	-
AL230	-	-	-	X	-	-	-	-
AL420	-	-	-	-	-	X	-	-
AL430	-	-	-	-	-	X	-	-
AL550	-	-	-	X	-	-	X	X
MLA 2-25 H	-	-	-	X	-	-	-	-
MLA 4-50 H	-	-	-	-	-	X	-	-
MLA 4-50 H-C	-	-	-	-	-	X	-	-
MLA 5-50 H	-	-	-	-	-	-	X	-
MLA 5-60 H-Z	-	-	-	X	-	-	X	X
R105	-	-	X	-	X	-	-	-
R135	-	-	X	-	X	-	-	-
RT105	-	-	X	-	X	-	-	-
RT135	-	-	X	-	X	-	-	-

VERPLICHTE UITRUSTING VAN MACHINES : ✕

	BLM 1520 / 480	BLM 1650 / 1100	BLM 1680 / 530	BLM 1680 / 670	BLM 1760 / 790	BLM 1760 / 820	BLM 1800 / 1200	BLM 1850 / 830
Capaciteit (kg)	480	810	530	670	820	790	810	860
Capaciteit van de koepel (l)	480	810	530	670	820	790	810	860
Gewicht (kg)	-	1100	160	242	275	264	1200	290
Totale hoogte (mm)	600	810	600	605	711	705	810	711
Breedte (mm)	1520	1650	1680	1680	1760	1760	1800	1850
Diepte (mm)	890	1224	890	1023	1020	1012	1224	1020
Machine-apparatuur	×	×	×	×	×	×	×	×
Flexibele buis	-	Nee	Nee	Nee	Nee	Nee	Nee	Nee

Machine compatibiliteit								
All-Tach®	N736014	N51502537	N736015	N747011	N757013	N51502468	N51502536	N757014
4 point Carriage	-	N51502603	-	-	-	-	N51502605	-
Euro Carriage	-	N51502562	-	-	-	-	N51502564	-
1350 R NXT2	X	-	X	-	-	-	-	-
1350 RT	X	-	X	-	-	-	-	-
1650 R	-	-	-	X	-	-	-	-
1650 RT	-	-	-	X	-	-	-	-
1900 R	-	-	-	X	-	-	-	-
2100V	-	-	-	X	-	X	-	X
2100VT	-	-	-	X	-	-	-	-
2200 R	-	-	-	-	-	X	-	-
2300V	-	-	-	-	X	X	-	X
2700 V NXT:2	-	-	-	-	X	-	-	X
2750V	-	-	-	-	X	-	-	-
AL650	-	X	-	-	-	-	X	-
AL750	-	X	-	-	-	-	X	-
MLA 6-65 H-Z	-	X	-	-	-	-	X	-
MLA 7-75 H-Z	-	X	-	-	-	-	X	-
R135	X	-	X	-	-	-	-	-
R165	-	-	-	X	-	-	-	-
R190	-	-	-	X	-	-	-	-
R220	-	-	-	-	-	X	-	-
RT135	X	-	X	-	-	-	-	-
RT165	-	-	-	X	-	-	-	-
V210 - NEW	-	-	-	X	-	X	-	X
V230 - NEW	-	-	-	-	X	X	-	X
V270	-	-	-	-	X	-	-	X
V275 - NEW	-	-	-	-	X	-	-	-
VT210 - NEW	-	-	-	X	-	-	-	-

VERPLICHTE UITRUSTING VAN MACHINES : ×

	BLM 1850 / 860	BLM 1850 / 1100	BLM 1950 / 1300	BLM 2080 / 1250	BLM 2140 / 1290	BLM 2150 / 1420	BLM 2350 / 1370 (a)	BLM 2350 / 1370 (b)
Capaciteit (kg)	830	1100	1300	1250	1290	1420	1370	1370
Capaciteit van de koepel (l)	830	1100	1300	1250	1290	1420	1370	1370
Gewicht (kg)	275	350	354	370	381	380	405	405
Totale hoogte (mm)	705	832	810	832	832	810	832	832
Breedte (mm)	1850	1850	1950	2080	2140	2150	2350	2350
Diepte (mm)	1012	1102	1224	1102	1102	1224	1102	1102
Machine-apparatuur	×	×	×	×	×	×	×	×
Flexibele buis	Nee	Nee	Nee	Nee	Nee	Nee	Nee	Nee

Machine compatibiliteit								
All-Tach®	N51502469	N51502037	N51502535	N51502076	N700248	N51502534	N700249	N51502038
4 point Carriage	-	-	N51502607	-	-	N51502609	-	-
Euro Carriage	-	-	N51502566	-	-	N51502568	-	-
1850 RT	-	X	-	-	-	-	-	-
2100VT	-	X	-	-	-	-	-	-
2150 RT	-	X	-	-	-	-	-	X
2200 R	X	-	-	-	-	-	-	-
2300V	X	-	-	-	-	-	-	-
2300VT	-	X	-	-	-	-	-	-
2600 R	X	-	-	X	-	-	-	-
2750V	X	-	-	X	-	-	-	-
2750VT	-	-	-	-	-	-	-	X
3300 V NXT:2	-	-	-	X	X	-	-	-
4200 V	-	-	-	X	X	-	X	-
AL650	-	-	X	-	-	-	-	-
AL750	-	-	X	-	-	X	-	-
MLA 6-65 H-Z	-	-	X	-	-	-	-	-
MLA 7-75 H-Z	-	-	X	-	-	X	-	-
R220	X	-	-	-	-	-	-	-
R260	X	-	-	X	-	-	-	-
RT185	-	X	-	-	-	-	-	-
RT215	-	X	-	-	-	-	-	X
V230 - NEW	X	-	-	-	-	-	-	-
V275 - NEW	X	-	-	X	-	-	-	-
V330	-	-	-	X	X	-	-	-
VT210 - NEW	-	X	-	-	-	-	-	-
VT230 - NEW	-	X	-	-	-	-	-	-
VT275 - NEW	-	-	-	-	-	-	-	X

VERPLICHTE UITRUSTING VAN MACHINES : ×



NEW

GROOT VOLUMEBAK (MHT)



- Max. density 1000kg/m³.
- 500HB bolted wear plate.
- Note: road circulation kit mandatory in Italy. Contact your dealer.
- High-resistance light material buckets adapted to the power of MHT heavy telehandlers.

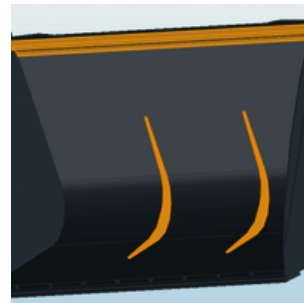

	CBA 2000 / 2500 LDR	CBA 2500 / 4000 LDR MHT	CBA 3000 / 2500 LDR	CBA 4000 / 2500 LDR
Capaciteit (kg)	2010	4000	3023	4007
Capaciteit van de koepel (l)	2010	4000	3023	4007
Slagcapaciteit (l)	1484	3420	2342	3195
Gewicht (kg)	679	1440	834	1311
Totale hoogte (mm)	1170	1690	1333	1617
Totale lengte (mm)	1365	2053	1661	1896
Breedte (mm)	2450	2500	2500	2500
Machine-apparatuur	×	×	×	×
Flexibele buis	-	-	Nee	Nee
Slijtplaat met bouten (LDR)	Standaard	Standaard	Standaard	Standaard

Machine compatibiliteit				
Referentienummer E-RECO	939160	52000534	939161	939162
MHT 790 ST5	X	-	X	X
MHT 10135 ST5	-	X	-	-
MHT 10160 ST5	-	X	-	-
MHT 10200 ST5	-	X	-	-
MHT 11250 ST5	-	X	-	-
MHT-X 790 Mining	-	-	-	X
MHT-X 790 ST3A	X	-	X	X
MHT-X 10135 ST3A	-	X	-	-
MHT-X 10160 ST3A	-	X	-	-
MHT-X 10200 ST3A	-	X	-	-
MHT-X 11250 ST3A	-	X	-	-

VERPLICHTE UITRUSTING VAN MACHINES : ×



GROOT VOLUME BKA MET SLIJTMES (COMPACTE MACHINES)



- Bestemd voor vrac materialen met een dichtheid $< 1 \text{ t/m}^3$.
- Slijtgedeelte in 400 HB voor een langere levensduur.
- Breed gamma bakken van verschillende capaciteiten.
- Grotere capaciteiten voor doeltreffende laadtoepassingen.

	BLM WP 1650 / 1100	BLM WP 1800 / 1200	BLM WP 1950 / 1300	BLM WP 2150 / 1420
Capaciteit (kg)	1100	1200	1300	1420
Capaciteit van de koepel (l)	1100	1200	1300	1420
Gewicht (kg)	342	365	387	417
Totale hoogte (mm)	810	810	810	810
Breedte (mm)	1650	1800	1950	2150
Diepte (mm)	1271	1271	1271	1271
Machine-apparatuur	×	×	×	×
Flexibele buis	Nee	Nee	Nee	Nee

Machine compatibiliteit

All-Tach®	N51502533	N51502532	N51502531	N51502530
4 point Carriage	N51502604	N51502606	N51502608	N51502610
Euro Carriage	N51502563	N51502565	N51502567	N51502569
AL650	X	X	X	-
AL750	X	X	X	X
MLA 6-65 H-Z	X	X	X	-
MLA 7-75 H-Z	X	X	X	X

VERPLICHTE UITRUSTING VAN MACHINES : ×



NEW

LIGHT MATERIAL BUCKET

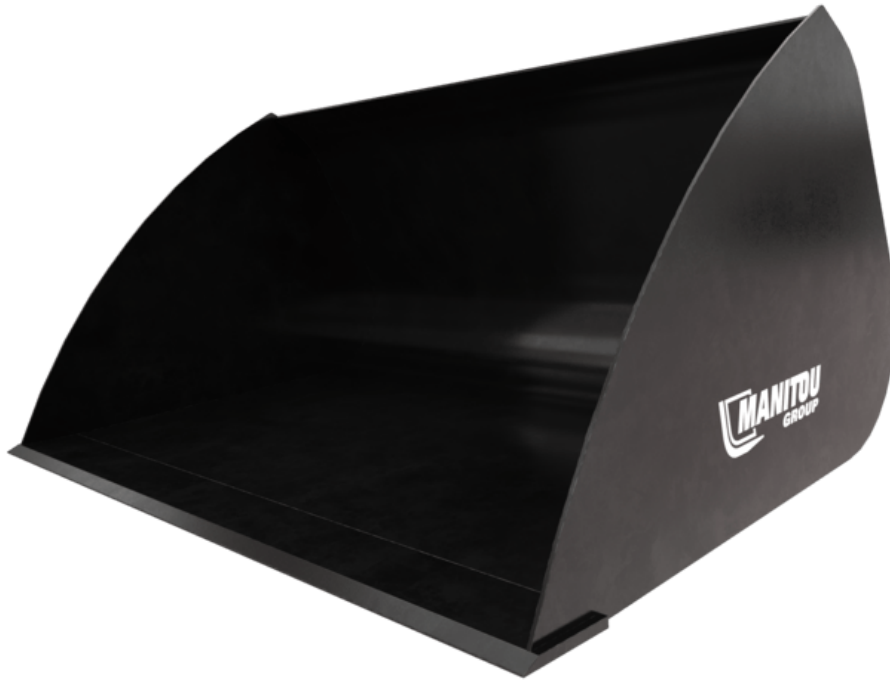

- Suited for bulk materials with a density $< 0.8\text{t/m}^3$.
- 400HB cutting edge for more resistance.
- High capacity for efficient loading applications.

	BLM 1500 / 770
Capaciteit (kg)	610
Capaciteit van de koepel (l)	763
Slagcapaciteit (l)	613
Gewicht (kg)	209
Totale hoogte (mm)	775
Totale lengte (mm)	1218
Breedte (mm)	1500
Machine-apparatuur	×

Machine compatibiliteit	
All-Tach®	52706270
4 point Carriage	52723640
Euro Carriage	52723641
GCT 3-14	X
GCT 3-14 +	X
ULM 412 H	X
ULM 412 H	X
ULM 415 H	X
ULM 415 H	X

VERPLICHTE UITRUSTING VAN MACHINES : ×



SCHEPBAK



- Breed gamma bakken met een capaciteit vanaf 600L.
- Bak aangepast om materialen te verhandelen met een dichtheid $\leq 2,1$.
- Versterkte structuur (basis, mes en zijanten).
- Vastgeboute slijtmes "LDR" in 500 HB in optie.
- TSDL : Bak te gebruiken op machines uitgerust met een geïntegreerde zijverstelling van het onderstel.
- De algemene bak voor een dagelijks gebruik.
- Basiswerktuig voor laad- en lostoepassingen.
- Robuust en eenvoudig te gebruiken. Beantwoordt aan heel wat verschillende eisen.
- Ideaal om bulkmaterialen te verhandelen: zand en losse steentjes, grond, gebroken glas, enz...

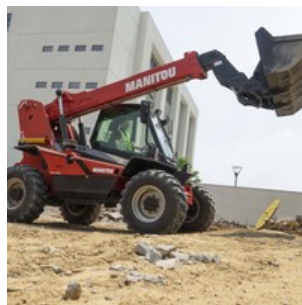

	CBR 600 / 1500	CBR 730 / 1850	CBR 780 / 1950	CBR 850 / 2100	CBR 900 / 2250	CBR 1000 / 2450	CBR 1000 / 2500
Capaciteit (kg)	1224	1543	1634	1770	1898	2079	2100
Capaciteit van de koepel (l)	583	735	778	843	904	990	1000
Slagcapaciteit (l)	487	600	663	685	736	804	822
Gewicht (kg)	274	318	328	358	360	381	664
Totale hoogte (mm)	776	794	775	775	775	775	815
Totale lengte (mm)	845	815	815	838	815	815	960
Breedte (mm)	1500	1850	1950	2100	2250	2450	2500
Machine-apparatuur	×	×	×	×	×	×	×
Slijtplaat met bouten (LDR)	Niet standaard	Niet standaard	Niet standaard	Niet standaard	Niet standaard	Niet standaard	Standaard

Machine compatibiliteit							
Referentienummer	570614	571831	570613	653047	653749	654716	-
Referentienummer slijtplaat met bouten (LDR)	52584881	52000369	-	-	-	52000370	52645107
Referentienummer TSDL	-	-	-	-	52000365	52000366	-
Referentievorkenbord schranklader	52000783	-	-	-	-	-	-
ALT950	-	-	-	-	-	X	-
MLA-T 533-145 V+ - ST5	-	-	-	-	-	X	-
MLT 420-60 H	X	-	-	-	-	-	-
MLT 625-75 H	-	X	-	-	-	-	-
MLT 630-115	-	-	-	X	X	-	-
MLT 630-115 V	-	-	-	X	X	-	-
MLT 630-115 V CP	-	-	-	X	X	-	-
MLT 635-130 PS+	-	-	-	-	-	X	-
MLT 635-140 V+	-	-	-	-	-	X	-
MLT 730-115 V	-	-	-	X	X	-	-
MLT 730-115 V CP	-	-	-	X	X	-	-
MLT 733-115	-	-	-	-	-	X	-
MLT 733-115 LSU	-	-	-	-	-	X	-
MLT 737-130 PS+	-	-	-	-	-	X	-
MLT 741-130 PS+	-	-	-	-	-	X	-
MLT 741-140 V+	-	-	-	-	-	X	-
MLT 841-145 PS+	-	-	-	-	-	X	-
MLT 850-145 V+	-	-	-	-	-	X	-
MLT 940-140 V+	-	-	-	-	-	X	-
MLT 961-160 V+ L	-	-	-	-	-	-	X
MLT 1041-145 PS+L	-	-	-	-	-	X	-
MLT-X 625-75 H	-	X	-	-	-	-	-
MLT-X 732	-	-	-	-	-	X	-
MLT-X 735 T LSU	-	-	X	-	X	X	-
MLT-X 735 T LSU (70 KW)	-	-	-	-	-	X	-
MLT-X 737-130 PS+	-	-	-	-	-	X	-
MLT-X 741-140 V+	-	-	-	-	-	X	-
MLT-X 741 T LSU	-	-	-	-	-	X	-
MLT-X 841 - 145 PS+	-	-	-	-	-	X	-
MLT-X 850-145 V+	-	-	-	-	-	X	-

CBR 600 / 1500	CBR 730 / 1850	CBR 780 / 1950	CBR 850 / 2100	CBR 900 / 2250	CBR 1000 / 2450	CBR 1000 / 2500
----------------	----------------	----------------	----------------	----------------	-----------------	-----------------

Machine compatibiliteit							
MLT-X 961-160 V+ L	-	-	-	-	-	-	X
MLT-X 1041-145 PS+L	-	-	-	-	-	X	-
MT 420 H	X	-	-	-	-	-	-
MT 625 e	-	X	-	-	-	-	-
MT 625 HA	-	X	-	-	-	-	-
MT 730 H	-	-	X	-	-	-	-
MT 733 Easy	-	-	-	-	-	X	-
MT 735 75D ST5	-	-	-	-	X	X	-
MT 930 H	-	-	X	-	-	-	-
MT 930 HA	-	-	X	-	-	-	-
MT 933 Easy	-	-	-	-	X	X	-
MT 935 75D ST5	-	-	-	-	X	X	-
MT 1033 easy	-	-	-	-	X	X	-
MT 1135 75 D	-	-	-	-	X	X	-
MT 1135 H 100D	-	-	-	-	X	X	-
MT 1135 easy ST5	-	-	-	-	X	X	-
MT 1135 H easy ST5	-	-	-	-	X	X	-
MT 1135 HA Easy ST5	-	-	-	-	X	-	-
MT 1135 ST5	-	-	-	-	-	X	-
MT 1335 75D ST5	-	-	-	-	X	X	-
MT 1335 100D ST5	-	-	-	-	X	X	-
MT 1335	-	-	-	-	-	X	-
MT 1335 H 75D ST5	-	-	-	-	X	X	-
MT 1335 H 100D ST5	-	-	-	-	X	X	-
MT 1335 HA 75D ST5	-	-	-	-	X	X	-
MT 1335 HA 100D ST5	-	-	-	-	X	X	-
MT 1335 ST5	-	-	-	-	-	X	-
MT 1440 A	-	-	X	-	X	X	-
MT 1440 A ST5	-	-	-	-	-	X	-
MT 1440 easy ST5	-	-	-	-	-	X	-
MT 1440 HA	-	-	X	-	X	X	-
MT 1440 HA ST5	-	-	-	-	-	X	-
MT 1440 ST5	-	-	-	-	-	X	-
MT 1840 A 100D ST5 S1	-	-	-	-	-	X	-
MT 1840 A	-	-	-	-	X	X	-
MT 1840 easy ST5	-	-	-	-	-	X	-
MT 1840 HA	-	-	-	-	-	X	-
MT 1840 HA	-	-	-	-	X	X	-
MT 1840 ST5	-	-	-	-	-	X	-
MT-X 625 H	-	X	-	-	-	-	-
MT-X 733	-	-	-	-	-	X	-
MT-X 733 Mining	-	-	X	-	X	X	-
MT-X 1033	-	-	-	-	X	X	-
MT-X 1033 Mining	-	-	-	-	X	X	-

CBR 600 / 1500 **CBR 730 / 1850** **CBR 780 / 1950** **CBR 850 / 2100** **CBR 900 / 2250** **CBR 1000 / 2450** **CBR 1000 / 2500**

Machine compatibiliteit							
MT-X 1033 A Mining	-	-	-	-	X	X	-
MT-X 1440	-	-	X	-	X	X	-
MT-X 1440 A	-	-	X	-	X	X	-
MT-X 1840	-	-	-	-	X	X	-
MT-X 1840 A	-	-	-	-	X	X	-

VERPLICHTE UITRUSTING VAN MACHINES : ✕



SCHEPBAK



- Breed gamma bakken met een capaciteit van 650 L tot 900 L.
- Constructiebakken aangepast om materialen te verhandelen met een densiteit $\leq 2,1$.
- Bac uitgerust met verwisselbare tanden.
- Bak bestemd voor een gebruik op machines uitgerust met een aankoppeling met geïntegreerde zijdelingse verplaatsing ("TSDL").
- Schepbak ontworpen voor intensief en langdurig gebruik. Speciaal ontwikkeld voor bouwplaatsen en grondverzet. Uitsrt stijve structuur voor een lange levensduur. Bak met tanden om vlot en krachtig in de aarde te scheppen.

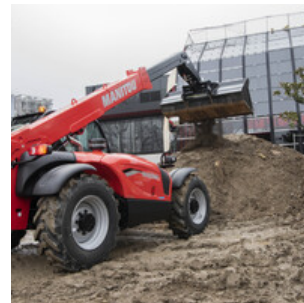
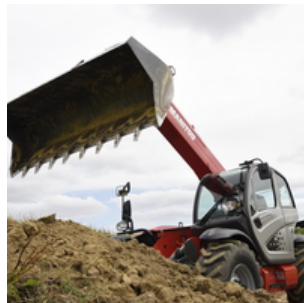

	CBC 500L / 1500	CBC 650L / 1850	CBC 700L / 1950	CBC 750L / 2100	CBC 800L / 2250	CBC 900L / 2450	CBC 1000L / 2500	CBC 1500L / 2500
Capaciteit (kg)	1090	1419	1461	1613	1709	1875	2100	3150
Capaciteit van de koepel (l)	519	676	696	768	814	893	1000	1500
Slagcapaciteit (l)	435	541	574	616	666	728	760	1159
Gewicht (kg)	280	320	330	345	366	391	693	669
Totale hoogte (mm)	810	810	810	810	810	810	805	957
Totale lengte (mm)	1048	1048	1048	1048	1026	1026	1001	1201
Breedte (mm)	1500	1850	1950	2100	2250	2450	2500	2500
Machine-apparatuur	×	×	×	×	×	×	×	×
Tanden	4	6	6	6	6	8	8	8
Minimum spreiding vorken (mm)	290	257	271	293	314	266	266	266

Machine compatibiliteit

Referentienummer	654474	654473	654472	654475	654471	654470	-	-
Referentienummer TSDL	-	-	-	-	52000363	52000364	-	-
Referentievorkenbord schranklader	52000784	-	-	-	-	-	-	-
MLT 420-60 H	X	-	-	-	-	-	-	-
MLT 630-115	-	-	-	X	X	-	-	-
MLT 630-115 V	-	-	-	X	X	-	-	-
MLT 630-115 V CP	-	-	-	X	X	-	-	-
MLT 635-130 PS+	-	-	-	-	-	X	-	-
MLT 635-140 V+	-	-	-	-	-	X	-	-
MLT 730-115 V	-	-	-	X	X	-	-	-
MLT 730-115 V CP	-	-	-	X	X	-	-	-
MLT 733-115	-	-	-	-	-	X	-	-
MLT 733-115 LSU	-	-	-	-	-	X	-	-
MLT 737-130 PS+	-	-	-	-	-	X	-	-
MLT 741-130 PS+	-	-	-	-	X	X	-	-
MLT 741-140 V+	-	-	-	-	X	X	-	-
MLT 841-145 PS+	-	-	-	-	-	X	-	-
MLT 850-145 V+	-	-	-	-	-	X	-	-
MLT 1041-145 PS+L	-	-	-	-	-	X	-	-
MLT-X 732	-	-	-	-	-	X	-	-
MLT-X 735 T LSU	-	-	-	-	-	X	-	-
MLT-X 737-130 PS+	-	-	-	-	-	X	-	-
MLT-X 741-140 V+	-	-	-	-	X	X	-	-
MLT-X 841 - 145 PS+	-	-	-	-	-	X	-	-
MLT-X 850-145 V+	-	-	-	-	-	X	-	-
MLT-X 1041-145 PS+L	-	-	-	-	-	X	-	-
MT 420 H	X	-	-	-	-	-	-	-
MT 625 e	-	X	-	-	-	-	-	-
MT 625 HA	-	X	-	-	-	-	-	-
MT 730 H	-	-	X	-	-	-	-	-
MT 733 Easy	-	-	-	-	-	X	-	-
MT 735 75D ST5	-	-	-	-	X	X	-	-
MT 930 H	-	-	X	-	-	-	-	-

CBC 500L / 1500	CBC 650L / 1850	CBC 700L / 1950	CBC 750L / 2100	CBC 800L / 2250	CBC 900L / 2450	CBC 1000L / 2500	CBC 1500L / 2500
--------------------	--------------------	--------------------	--------------------	--------------------	--------------------	---------------------	---------------------

Machine compatibiliteit								
MT 930 HA	-	-	X	-	-	-	-	-
MT 933 Easy	-	-	-	-	-	X	-	-
MT 935 75D ST5	-	-	-	-	X	X	-	-
MT 1033 easy	-	-	-	-	X	X	-	-
MT 1135 75 D	-	-	-	-	X	X	-	-
MT 1135 H 100D	-	-	-	-	X	X	-	-
MT 1335 75D ST5	-	-	-	-	X	X	-	-
MT 1335 100D ST5	-	-	-	-	X	X	-	-
MT 1335	-	-	-	-	-	X	-	-
MT 1335 H 75D ST5	-	-	-	-	X	X	-	-
MT 1335 H 100D ST5	-	-	-	-	X	X	-	-
MT 1335 HA 75D ST5	-	-	-	-	X	X	-	-
MT 1335 HA 100D ST5	-	-	-	-	X	X	-	-
MT 1440 A	-	-	X	-	X	X	-	-
MT 1440 HA	-	-	X	-	X	X	-	-
MT 1840 A	-	-	-	-	X	X	-	-
MT 1840 HA	-	-	-	-	X	X	-	-
MT-X 420 H	X	-	-	-	-	-	-	-
MT-X 625 H	-	X	-	-	-	-	-	-
MT-X 733	-	-	-	-	-	X	-	-
MT-X 1033	-	-	-	-	X	X	-	-
MT-X 1440	-	-	X	-	X	X	-	-
MT-X 1440 A	-	-	X	-	X	X	-	-
MT-X 1840	-	-	-	-	X	X	-	-
MT-X 1840 A	-	-	-	-	X	X	-	-
MXT 840 K	-	-	-	-	-	X	-	-
MXT 840 P	-	-	-	-	-	X	-	-
MXT 1740 K	-	-	-	-	-	X	-	-
MXT 1740 P	-	-	-	-	-	X	-	-
Referentienummer E-RECO	-	-	-	-	-	-	939163	939164
MHT 790 ST5	-	-	-	-	-	-	X	X
MHT-X 790 Mining	-	-	-	-	-	-	-	X
MHT-X 790 ST3A	-	-	-	-	-	-	X	X

VERPLICHTE UITRUSTING VAN MACHINES : ✕



NEW

SCHEPBAK (MHT)



- Strong attachments for a long lasting life.
- 500HB bolted wear plate.
- Note: road circulation kit mandatory in Italy. Contact your dealer.
- High-resistance general purpose buckets adapted to the power of MHT heavy telehandlers.

	CBR 1000 / 2500	CBR 1500 / 2500	CBR 2000 / 2500 LDR MHT
Capaciteit (kg)	2100	3150	4200
Capaciteit van de koepel (l)	1000	1500	2000
Slagcapaciteit (l)	822	1218	1810
Gewicht (kg)	693	540	926
Totale hoogte (mm)	794	941	1168
Totale lengte (mm)	988	1188	1418
Breedte (mm)	2500	2500	2500
Machine-apparatuur	×	×	×
Flexibele buis	Nee	Nee	Nee
Slijtplaat met bouten (LDR)	Standaard	Standaard	Standaard

Machine compatibiliteit			
Referentienummer E-RECO	939165	939166	52000532
MHT 790 ST5	X	X	-
MHT 10135 ST5	-	-	X
MHT 10160 ST5	-	-	X
MHT 10200 ST5	-	-	X
MHT 11250 ST5	-	-	X
MHT-X 790 Mining	X	X	-
MHT-X 790 ST3A	X	X	-
MHT-X 10135 ST3A	-	-	X
MHT-X 10160 ST3A	-	-	X
MHT-X 10200 ST3A	-	-	X
MHT-X 11250 Mining	-	-	X
MHT-X 11250 ST3A	-	-	X

VERPLICHTE UITRUSTING VAN MACHINES : ×



NEW

SCHEPBAK (MRT)



- Bucket dedicated to the handling of all heavy materials (< 2100kg/m³).
- Available with an optional bolt-on wear plate to operate on concrete/ asphalt floor.
- Note: rotating telehandlers are not designed for intensive loading applications or for digging applications.
- Perfect for the handling of sand, gravels etc.
- Designed to suit to MRT's specific boom head position.

	CBR 1000 / 2450 (a)	CBR 1000 / 2450 (b)
Capaciteit (kg)	2100	2100
Capaciteit van de koepel (l)	1000	1000
Gewicht (kg)	415	441
Totale hoogte (mm)	802	820
Totale lengte (mm)	890	922
Breedte (mm)	2450	2450
Machine-apparatuur	×	×
Flexibele buis	Nee	Nee
Slijtplaat met bouten (LDR)	-	Standaard

Machine compatibiliteit		
Referentienummer E-RECO	921282	923967
MRT 1645 75	X	X
MRT 1645 115	X	X
MRT 1845 75	X	X
MRT 1845 115	X	X
MRT 2145 115	X	X
MRT 2260	X	X
MRT 2260 e	X	X
MRT 2545 115	X	X
MRT 2570	X	X
MRT 2660	X	X
MRT 2660 e	X	X
MRT 3060	X	X
MRT 3570	X	X
MRT 3570 ES	X	X
MRT-X 1645	X	X
MRT-X 1845	X	X
MRT-X 2145	X	X
MRT-X 2260	X	X
MRT-X 2545	X	X
MRT-X 2570	X	X
MRT-X 2660	X	X
MRT-X 3060	X	X
MRT-X 3570	X	X
MRT-X 3570 ES	X	X

VERPLICHTE UITRUSTING VAN MACHINES : ×



NEW

SCHEPBAK - ESSENTIEEL



- Capacity: 400 up to 1000L.
- For material density up to 2100 kg/m³.
- Simplified structure with straight sides.
- Integrated level indicator.
- No side strengthener.
- A bucket for all construction applications.
- Dedicated to heavy bulk: sand, earth, stones, gravels, etc.
- Tested at the R&D Center on high demanding applications.
- Designed and validated by Manitou.



	BGP 1500 / 400 Essential	BGP 1850 / 750 Essential	BGP 2000 / 800 Essential	BGP 2300 / 900 Essential	BGP 2450 / 1000 Essential
Capaciteit (kg)	827	1550	1684	1955	2089
Capaciteit van de koepel (l)	394	738	802	931	995
Slagcapaciteit (l)	311	574	622	718	766
Gewicht (kg)	161	326	345	379	397
Totale hoogte (mm)	625	786	786	786	786
Totale lengte (mm)	812	975	925	975	925
Breedte (mm)	1500	1850	2000	2300	2450
Diepte (mm)	627	817	817	817	817
Machine-apparatuur	×	×	×	×	×
Flexibele buis	-	-	Nee	-	-

Machine compatibiliteit					
Referentienummer	-	52690766	52688160	52690756	52658055
All-Tach®	52702290	-	-	-	-
4 point Carriage	52723638	-	-	-	-
Euro Carriage	52723639	-	-	-	-
GCT 3-14	X	-	-	-	-
GCT 3-14 +	X	-	-	-	-
MLT 630-115	-	-	X	-	-
MLT 630-115 V	-	-	X	-	-
MLT 630-115 V CP	-	-	X	-	-
MLT 635-130 PS+	-	-	-	-	X
MLT 635-140 V+	-	-	-	-	X
MLT 730-115 V	-	-	X	-	-
MLT 730-115 V CP	-	-	X	-	-
MLT 733-115	-	-	-	-	X
MLT 733-115 LSU	-	-	-	-	X
MLT 737-130 PS+	-	-	-	-	X
MLT 741-130 PS+	-	-	-	-	X
MLT 741-140 V+	-	-	-	-	X
MLT 841-145 PS+	-	-	-	-	X
MLT 940-140 V+	-	-	-	-	X
MLT 1041-145 PS+L	-	-	-	-	X
MLT-X 732	-	-	-	-	X
MLT-X 735 T LSU	-	-	-	-	X
MLT-X 735 T LSU (70 KW)	-	-	-	-	X
MLT-X 737-130 PS+	-	-	-	-	X
MLT-X 741-140 V+	-	-	-	-	X
MLT-X 741 T LSU	-	-	-	-	X
MLT-X 841 - 145 PS+	-	-	-	-	X
MLT-X 1035 LT LSU	-	-	-	-	X
MLT-X 1041-145 PS+L	-	-	-	-	X
MT 625 e	-	X	-	-	-
MT 625 HA	-	X	-	-	-
MT 730 H	-	-	X	-	-
MT 733 Easy	-	-	-	X	X

BGP 1500 / 400 Essential	BGP 1850 / 750 Essential	BGP 2000 / 800 Essential	BGP 2300 / 900 Essential	BGP 2450 / 1000 Essential
-----------------------------	-----------------------------	-----------------------------	-----------------------------	------------------------------

Machine compatibiliteit					
MT 735 75D ST5	-	-	-	-	X
MT 930 H	-	-	X	-	-
MT 930 HA	-	-	X	-	-
MT 933 Easy	-	-	-	X	X
MT 935 75D ST5	-	-	-	-	X
MT 1033 easy	-	-	-	X	X
MT 1135 75 D	-	-	-	-	X
MT 1135 H 100D	-	-	-	-	X
MT 1135 easy ST5	-	-	-	X	X
MT 1135 H easy ST5	-	-	-	X	X
MT 1135 HA Easy ST5	-	-	-	X	X
MT 1135 ST5	-	-	-	X	X
MT 1335 75D ST5	-	-	-	-	X
MT 1335 100D ST5	-	-	-	-	X
MT 1335	-	-	-	X	X
MT 1335 easy ST5	-	-	-	X	X
MT 1335 H 75D ST5	-	-	-	-	X
MT 1335 H 100D ST5	-	-	-	-	X
MT 1335 H easy ST5	-	-	-	X	X
MT 1335 HA 75D ST5	-	-	-	-	X
MT 1335 HA 100D ST5	-	-	-	-	X
MT 1335 HA easy ST5	-	-	-	X	X
MT 1335 ST5	-	-	-	X	X
MT 1440 A	-	-	-	X	-
MT 1440 A ST5	-	-	-	X	X
MT 1440 easy ST5	-	-	-	X	X
MT 1440 HA	-	-	-	X	-
MT 1440 HA ST5	-	-	-	X	X
MT 1440 ST5	-	-	-	X	X
MT 1840 A 100D ST5 S1	-	-	-	X	X
MT 1840 A	-	-	-	X	-
MT 1840 easy ST5	-	-	-	X	X
MT 1840 HA	-	-	-	X	X
MT 1840 HA	-	-	-	X	-
MT 1840 ST5	-	-	-	X	X
MT-X 625 H	-	X	-	-	-
MT-X 733	-	-	-	X	X
MT-X 733 Mining	-	-	-	X	-
MT-X 1033	-	-	-	X	X
MT-X 1033 Mining	-	-	-	X	-
MT-X 1033 A Mining	-	-	-	X	-
MT-X 1440	-	-	-	X	X
MT-X 1440 A	-	-	-	X	X
MT-X 1840	-	-	-	X	X

BGP 1500 / 400 Essential	BGP 1850 / 750 Essential	BGP 2000 / 800 Essential	BGP 2300 / 900 Essential	BGP 2450 / 1000 Essential
-----------------------------	-----------------------------	-----------------------------	-----------------------------	------------------------------

Machine compatibiliteit					
MT-X 1840 A	-	-	-	X	X
ULM 412 H	X	-	-	-	-
ULM 412 H	X	-	-	-	-
ULM 415 H	X	-	-	-	-
ULM 415 H	X	-	-	-	-

VERPLICHTE UITRUSTING VAN MACHINES : ✕



SLOOPBAK MET HOGE WEERSTAND (COMPACTE MACHINES)



- Versterkte structuur: zijkanten, bovenkant, enz.
- Slijtstukken en zijdelingse stripen in 400 HB.
- Bak met laag profiel: zeer goede indringing van de materialen en toegang tot de cabine.
- Zeer robuust bak voor zware toepassingen: afbraak, scheepsbouw, enz...

	BD 1080 / 180	BD 1380 / 320	BD 1520 / 350	BD 1680 / 670	BD 1760 / 500	BD 1760 / 580	BD 1760 / 700
Capaciteit van de koepel (l)	180	320	350	670	580	500	700
Gewicht (kg)	68	137	143	295	190	190	305
Totale hoogte (mm)	427	470	470	600	501	502	600
Breedte (mm)	1080	1380	1520	1680	1760	1760	1760
Diepte (mm)	700	841	841	1100	916	924	1100
Machine-apparatuur	×	×	×	×	×	×	×
Flexibele buis	Nee	Nee	Nee	Nee	Nee	Nee	Nee

Machine compatibiliteit							
All-Tach®	N726005	N736008	N736009	N51502029	N51502464	N757007	N51502030
850 R	X	-	-	-	-	-	-
1050 R	-	X	-	-	-	-	-
1050 RT	-	X	-	-	-	-	-
1350 R NXT2	-	X	X	-	-	-	-
1350 RT	-	X	X	-	-	-	-
1640 E	X	-	-	-	-	-	-
1650 R	-	-	-	-	-	X	-
1650 RT	-	-	-	-	-	X	-
1850 RT	-	-	-	X	-	-	X
1900 R	-	-	-	-	X	-	-
2100V	-	-	-	-	X	-	-
2100VT	-	-	-	X	-	-	X
2200 R	-	-	-	-	X	-	-
2300V	-	-	-	-	X	-	-
2700 V NXT:2	-	-	-	-	-	X	-
2750V	-	-	-	-	-	X	-
R105	-	X	-	-	-	-	-
R135	-	X	X	-	-	-	-
R165	-	-	-	-	-	X	-
R190	-	-	-	-	X	-	-
R220	-	-	-	-	X	-	-
RT105	-	X	-	-	-	-	-
RT135	-	X	X	-	-	-	-
RT165	-	-	-	-	-	X	-
RT185	-	-	-	X	-	-	X
V210 - NEW	-	-	-	-	X	-	-
V230 - NEW	-	-	-	-	X	-	-
V270	-	-	-	-	-	X	-
V275 - NEW	-	-	-	-	-	X	-
VT210 - NEW	-	-	-	X	-	-	X

	BD 1830 / 520	BD 1830 / 600	BD 1850 / 740	BD 1880 / 750	BD 2140 / 870 (a)	BD 2140 / 870 (b)
Capaciteit van de koepel (l)	600	520	740	750	870	870
Gewicht (kg)	220	206	315	315	320	330
Totale hoogte (mm)	501	502	600	600	600	600
Breedte (mm)	1830	1830	1850	1880	2140	2140
Diepte (mm)	916	924	1100	1100	1100	1100
Machine-apparatuur	×	×	×	×	×	×
Flexibele buis	Nee	Nee	Nee	Nee	Nee	Nee

Machine compatibiliteit						
All-Tach®	N51502465	N757008	N51502031	N51502073	N700246	N51502032
1850 RT	-	-	X	-	-	-
2100VT	-	-	X	-	-	-
2150 RT	-	-	X	-	-	X
2200 R	-	X	-	-	-	-
2300V	X	-	-	-	-	-
2300VT	-	-	X	-	-	-
2600 R	-	X	-	X	-	-
2700 V NXT:2	X	-	-	-	-	-
2750V	X	X	-	X	-	-
2750VT	-	-	-	-	-	X
3300 V NXT:2	-	-	-	X	X	-
4200 V	-	-	-	-	X	-
R220	-	X	-	-	-	-
R260	-	X	-	X	-	-
RT185	-	-	X	-	-	-
RT215	-	-	X	-	-	X
V230 - NEW	X	-	-	-	-	-
V270	X	-	-	-	-	-
V275 - NEW	X	X	-	X	-	-
V330	-	-	-	X	X	-
VT210 - NEW	-	-	X	-	-	-
VT230 - NEW	-	-	X	-	-	-
VT275 - NEW	-	-	-	-	-	X



STANDAARD GRAAFBAK (COMPACTE MACHINES)



- 400 HB stalen versterkingen onder de bak.
- Robuuste bouw.

	BS 920 / 150	BS 1080 / 180	BS 1250 / 280	BS 1300 / 440	BS 1380 / 320	BS 1400 / 410	BS 1400 / 470
Capaciteit van de koepel (l)	150	180	280	440	320	410	470
Gewicht (kg)	50	55	134	190	137	180	203
Totale hoogte (mm)	427	427	470	732	470	675	732
Breedte (mm)	920	1080	1250	1300	1380	1400	1400
Diepte (mm)	700	700	841	817	841	760	817
Machine-apparatuur	×	×	×	×	×	×	×
Flexibele buis	Nee	Nee	Nee	Nee	Nee	Nee	Nee

Machine compatibiliteit							
All-Tach®	N726001	N726002	N736001	N004079	N736002	N004077	N004080
4 point Carriage	-	-	-	N003079	-	52807869	N003080
Euro Carriage	-	-	-	N51502179	-	N51502155	N51502180
850 R	X	X	-	-	-	-	-
1050 R	-	-	X	-	X	-	-
1050 RT	-	-	X	-	X	-	-
1350 R NXT2	-	-	-	-	X	-	-
1350 RT	-	-	X	-	X	-	-
1640 E	X	X	-	-	-	-	-
AL420	-	-	-	-	-	X	-
AL430	-	-	-	-	-	X	-
AL550	-	-	-	X	-	-	X
MLA 4-50 H	-	-	-	-	-	X	-
MLA 4-50 H-C	-	-	-	-	-	X	-
MLA 5-60 H-Z	-	-	-	X	-	-	X
R105	-	-	X	-	X	-	-
R135	-	-	-	-	X	-	-
RT105	-	-	X	-	X	-	-
RT135	-	-	-	-	X	-	-

VERPLICHTE UITRUSTING VAN MACHINES : ✕

	BS 1480 / 340	BS 1500 / 510	BS 1520 / 350	BS 1550 / 360	BS 1650 / 730	BS 1680 / 400	BS 1680 / 480
Capaciteit van de koepel (l)	340	510	350	360	730	400	480
Gewicht (kg)	141	216	143	150	265	148	188
Totale hoogte (mm)	470	732	470	470	730	450	502
Breedte (mm)	1480	1500	1525	1550	1650	1680	1680
Diepte (mm)	841	817	841	841	1024	843	924
Machine-apparatuur	×	×	×	×	×	×	×
Flexibele buis	Nee	Nee	Nee	Nee	Nee	Nee	Nee

Machine compatibiliteit							
All-Tach®	N736061	N004081	N736003	N736065	N51502506	N747002	N51502457
4 point Carriage	-	N003081	-	-	N51502611	-	-
Euro Carriage	-	N51502181	-	-	N51502570	-	-
1050 R	X	-	-	-	-	-	-
1050 RT	X	-	-	-	-	-	-
1350 R NXT2	X	-	X	X	-	-	-
1350 RT	X	-	X	X	-	-	-
1650 R	-	-	-	-	-	X	-
1650 RT	-	-	-	X	-	X	-
1900 R	-	-	-	-	-	-	X
2100V	-	-	-	-	-	-	X
2100VT	-	-	-	-	-	X	-
AL550	-	X	-	-	-	-	-
AL650	-	-	-	-	X	-	-
AL750	-	-	-	-	X	-	-
MLA 5-60 H-Z	-	X	-	-	-	-	-
MLA 6-65 H-Z	-	-	-	-	X	-	-
MLA 7-75 H-Z	-	-	-	-	X	-	-
R105	X	-	-	-	-	-	-
R135	X	-	X	-	-	-	-
R165	-	-	-	-	-	X	-
R190	-	-	-	-	-	-	X
RT105	X	-	-	-	-	-	-
RT135	X	-	X	X	-	-	-
RT165	-	-	-	X	-	X	-
V210 - NEW	-	-	-	-	-	-	X
VT210 - NEW	-	-	-	-	-	X	-

VERPLICHTE UITRUSTING VAN MACHINES : ✕

	BS 1680 / 670	BS 1760 / 500	BS 1760 / 580	BS 1760 / 700	BS 1800 / 800	BS 1830 / 520	BS 1830 / 600
Capaciteit van de koepel (l)	670	580	500	700	800	600	520
Gewicht (kg)	295	190	190	305	285	220	206
Totale hoogte (mm)	600	801	502	600	730	501	502
Breedte (mm)	1680	1760	1760	1760	1800	1830	1830
Diepte (mm)	1100	916	924	1100	1024	916	924
Machine-apparatuur	×	×	×	×	×	×	×
Flexibele buis	Nee	Nee	Nee	Nee	Nee	Nee	Nee

Machine compatibiliteit							
All-Tach®	N51502021	N51502459	N748001	N51502022	N51502505	N51502461	N757073
4 point Carriage	-	-	-	-	N51502614	-	-
Euro Carriage	-	-	-	-	N51502573	-	-
1650 R	-	-	X	-	-	-	-
1650 RT	-	-	X	-	-	-	-
1850 RT	X	-	-	X	-	-	-
1900 R	-	X	-	-	-	-	-
2100V	-	X	X	-	-	-	-
2100VT	-	-	X	-	-	-	-
2200 R	-	X	-	-	-	X	-
2300V	-	X	X	-	-	X	-
2300VT	X	-	-	X	-	-	-
2600 R	-	-	-	-	-	X	-
2700 V NXT:2	-	-	X	-	-	-	X
2750V	-	-	X	-	-	-	X
2750VT	-	-	-	X	-	-	-
AL650	-	-	-	-	X	-	-
AL750	-	-	-	-	X	-	-
MLA 6-65 H-Z	-	-	-	-	X	-	-
MLA 7-75 H-Z	-	-	-	-	X	-	-
R165	-	-	X	-	-	-	-
R190	-	X	-	-	-	-	-
R220	-	X	-	-	-	X	-
R260	-	-	-	-	-	X	-
RT165	-	-	X	-	-	-	-
RT185	X	-	-	X	-	-	-
V210 - NEW	-	X	X	-	-	-	-
V230 - NEW	-	X	X	-	-	X	-
V270	-	-	X	-	-	-	X
V275 - NEW	-	-	X	-	-	-	X
VT210 - NEW	-	-	X	-	-	-	-
VT230 - NEW	X	-	-	X	-	-	-
VT275 - NEW	-	-	-	X	-	-	-

VERPLICHTE UITRUSTING VAN MACHINES : ✕

	BS 1850 / 740	BS 1880 / 750	BS 1950 / 860	BS 2140 / 870 (a)	BS 2140 / 870 (b)	BS 2150 / 950
Capaciteit van de koepel (l)	740	750	870	870	870	960
Gewicht (kg)	315	315	300	320	230	333
Totale hoogte (mm)	600	600	730	600	600	730
Breedte (mm)	1850	1880	1950	2140	2140	2150
Diepte (mm)	1100	1100	1024	1100	1100	1024
Machine-apparatuur	×	×	×	×	×	×
Flexibele buis	Nee	Nee	Nee	Nee	Nee	Nee

Machine compatibiliteit						
All-Tach®	N51502023	N51502071	N51502547	N700244	N51502024	N51502546
4 point Carriage	-	-	N51502617	-	-	N51502620
Euro Carriage	-	-	N51502576	-	-	N51502579
1850 RT	X	-	-	-	-	-
2150 RT	X	-	-	-	X	-
2300VT	X	-	-	-	-	-
2600 R	-	X	-	-	-	-
2750V	-	X	-	-	-	-
2750VT	-	-	-	-	X	-
3300 V NXT:2	-	X	-	X	-	-
4200 V	-	-	-	X	-	-
AL650	-	-	X	-	-	-
AL750	-	-	X	-	-	X
MLA 6-65 H-Z	-	-	X	-	-	-
MLA 7-75 H-Z	-	-	X	-	-	X
R260	-	X	-	-	-	-
RT185	X	-	-	-	-	-
RT215	X	-	-	-	X	-
V275 - NEW	-	X	-	-	-	-
V330	-	X	-	X	-	-
VT230 - NEW	X	-	-	-	-	-
VT275 - NEW	-	-	-	-	X	-

VERPLICHTE UITRUSTING VAN MACHINES : ✕



STANDAARD GRAAFBAK MET TANDEN (COMPACTE MACHINES)

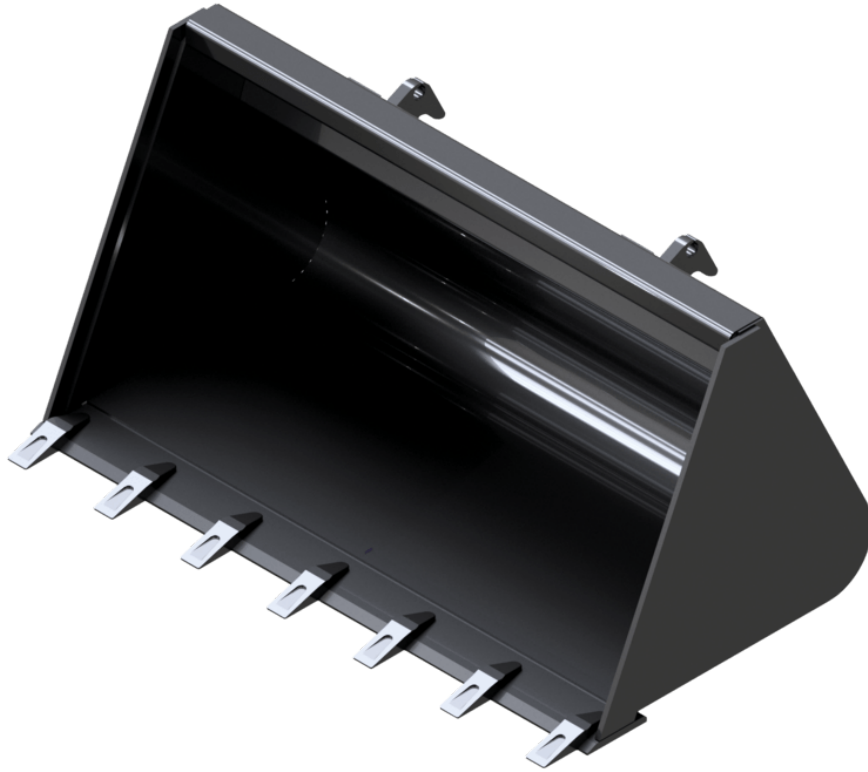

- HD-bouttanden voor efficiënter graven.
- 400 HB stalen versterkingen onder de bak.

- Ontworpen voor alle bouwtoepassingen.

	BS 920 / 150 T	BS 1080 / 180 T	BS 1250 / 280 T	BS 1300 / 400 T	BS 1380 / 320 T	BS 1400 / 470 T	BS 1480 / 340 T
Capaciteit van de koepel (l)	150	180	280	400	320	470	340
Gewicht (kg)	50	55	134	196	137	210	141
Totale hoogte (mm)	427	427	470	732	470	732	470
Breedte (mm)	920	1080	1250	1300	1380	1400	1480
Diepte (mm)	700	700	841	907	841	907	841
Machine-apparatuur	×	×	×	×	×	×	×
Tanden	5	6	6	6	7	7	7
Flexibele buis	Nee	Nee	Nee	Nee	Nee	Nee	Nee

Machine compatibiliteit							
All-Tach®	N726003	N726004	N736004	N004085	N736005	N004086	N736062
4 point Carriage	-	-	-	N003085	-	N003086	-
Euro Carriage	-	-	-	N51502182	-	N51502183	-
850 R	X	X	-	-	-	-	-
1050 R	-	-	X	-	X	-	X
1050 RT	-	-	X	-	X	-	X
1350 R NXT2	-	-	-	-	X	-	X
1350 RT	-	-	X	-	X	-	X
1640 E	X	X	-	-	-	-	-
AL550	-	-	-	X	-	X	-
MLA 5-60 H-Z	-	-	-	X	-	X	-
R105	-	-	X	-	X	-	X
R135	-	-	-	-	X	-	X
RT105	-	-	X	-	X	-	X
RT135	-	-	-	-	X	-	X

VERPLICHTE UITRUSTING VAN MACHINES : ×

	BS 1500 / 510 T	BS 1520 / 350 T	BS 1550 / 360 T	BS 1650 / 730 T	BS 1680 / 400 T (a)	BS 1680 / 400 T (b)	BS 1680 / 480 T
Capaciteit van de koepel (l)	510	350	360	730	400	400	480
Gewicht (kg)	223	143	150	273	148	148	-
Totale hoogte (mm)	732	470	470	730	450	450	502
Breedte (mm)	1500	1520	1550	1650	1680	1680	1680
Diepte (mm)	907	841	841	1124	843	843	924
Machine-apparatuur	×	×	×	×	×	×	×
Tanden	7	7	7	8	8	8	8
Flexibele buis	Nee	Nee	Nee	Nee	Nee	Nee	-

Machine compatibiliteit							
All-Tach®	N004091	N736006	N736066	N51502541	N747005	N51502459	N51502458
4 point Carriage	N003091	-	-	N51502612	-	-	-
Euro Carriage	N51502184	-	-	N51502571	-	-	-
1350 R NXT2	-	X	X	-	-	-	-
1350 RT	-	X	X	-	X	-	-
1650 R	-	-	-	-	X	-	-
1650 RT	-	-	X	-	X	-	-
1900 R	-	-	-	-	-	X	X
2100V	-	-	-	-	X	-	X
AL550	X	-	-	-	-	-	-
AL650	-	-	-	X	-	-	-
AL750	-	-	-	X	-	-	-
MLA 5-60 H-Z	X	-	-	-	-	-	-
MLA 6-65 H-Z	-	-	-	X	-	-	-
MLA 7-75 H-Z	-	-	-	X	-	-	-
R165	-	-	-	-	X	-	-
R190	-	-	-	-	-	-	X
RT135	-	X	X	-	-	-	-
RT165	-	-	X	-	X	-	-
V210 - NEW	-	-	-	-	X	-	X

VERPLICHTE UITRUSTING VAN MACHINES : ×

	BS 1680 / 670 T	BS 1760 / 500 T	BS 1760 / 580 T	BS 1760 / 700 T	BS 1800 / 800 T	BS 1830 / 520 T	BS 1830 / 600 T
Capaciteit van de koepel (l)	670	580	500	700	800	600	520
Gewicht (kg)	295	190	190	305	294	220	206
Totale hoogte (mm)	600	501	502	600	730	501	502
Breedte (mm)	1680	1760	1760	1760	1800	1830	1830
Diepte (mm)	1100	916	924	1100	1124	916	924
Machine-apparatuur	×	×	×	×	×	×	×
Tanden	8	8	8	8	9	9	9
Flexibele buis	Nee	Nee	Nee	Nee	Nee	Nee	Nee

Machine compatibiliteit							
All-Tach®	N51502025	N51502460	N748002	N51502026	N51502540	N51502462	N757074
4 point Carriage	-	-	-	-	N51502615	-	-
Euro Carriage	-	-	-	-	N51502574	-	-
1650 R	-	-	X	-	-	-	-
1650 RT	-	-	X	-	-	-	-
1850 RT	X	-	-	X	-	-	-
1900 R	-	X	-	-	-	-	-
2100V	-	X	-	-	-	-	-
2100VT	X	-	-	-	-	-	-
2200 R	-	X	-	-	-	X	-
2300V	-	X	X	-	-	X	-
2300VT	-	-	X	-	-	-	-
2600 R	-	-	-	-	-	X	-
2700 V NXT:2	-	-	X	-	-	-	X
2750V	-	-	X	-	-	-	X
AL650	-	-	-	-	X	-	-
AL750	-	-	-	-	X	-	-
MLA 6-65 H-Z	-	-	-	-	X	-	-
MLA 7-75 H-Z	-	-	-	-	X	-	-
R165	-	-	X	-	-	-	-
R190	-	X	-	-	-	-	-
R220	-	X	-	-	-	X	-
R260	-	-	-	-	-	X	-
RT165	-	-	X	-	-	-	-
RT185	X	-	-	X	-	-	-
V210 - NEW	-	X	-	-	-	-	-
V230 - NEW	-	X	X	-	-	X	-
V270	-	-	X	-	-	-	X
V275 - NEW	-	-	X	-	-	-	X
VT210 - NEW	X	-	-	-	-	-	-
VT230 - NEW	-	-	X	-	-	-	-

VERPLICHTE UITRUSTING VAN MACHINES : ×

	BS 1850 / 740 T	BS 1880 / 750 T	BS 1950 / 860 T	BS 2140 / 870 T (a)	BS 2140 / 870 T (b)	BS 2150 / 950 T
Capaciteit van de koepel (l)	740	750	870	870	870	960
Gewicht (kg)	315	315	309	320	230	344
Totale hoogte (mm)	600	600	730	600	600	730
Breedte (mm)	1850	1880	1950	2140	2140	2150
Diepte (mm)	1100	1100	1124	1100	1100	1124
Machine-apparatuur	×	×	×	×	×	×
Tanden	9	9	9	11	11	11
Flexibele buis	Nee	Nee	Nee	Nee	Nee	Nee

Machine compatibiliteit

All-Tach®	N51502027	N51502072	N51502539	N700245	N51502028	N51502538
4 point Carriage	-	-	N51502619	-	-	N51502621
Euro Carriage	-	-	N51502578	-	-	N51502580
1850 RT	X	-	-	-	-	-
2150 RT	X	-	-	-	X	-
2300VT	X	-	-	-	-	-
2600 R	-	X	-	-	-	-
2750V	-	X	-	-	-	-
2750VT	-	-	-	-	X	-
3300 V NXT:2	-	X	-	X	-	-
4200 V	-	-	-	X	-	-
AL650	-	-	X	-	-	-
AL750	-	-	X	-	-	X
MLA 6-65 H-Z	-	-	X	-	-	-
MLA 7-75 H-Z	-	-	X	-	-	X
R260	-	X	-	-	-	-
RT185	X	-	-	-	-	-
RT215	X	-	-	-	X	-
V275 - NEW	-	X	-	-	-	-
V330	-	X	-	X	-	-
VT230 - NEW	X	-	-	-	-	-
VT275 - NEW	-	-	-	-	X	-

VERPLICHTE UITRUSTING VAN MACHINES : ×



STANDAARD GRAAFBAK MET TANDEN EN SLIJTMES (COMPACTE MACHINES)



- 400 HB stalen versterkingen onder de bak.
- 400 HB stalen slijtblad voor extra sterkte.

- Ontworpen voor alle bouwtoepassingen.

	BS WP 1650 / 730	BS WP 1800 / 800	BS WP 1950 / 860	BS WP 2150 / 950
Capaciteit van de koepel (l)	730	800	870	960
Gewicht (kg)	302	325	343	381
Totale hoogte (mm)	730	730	730	730
Breedte (mm)	1650	1800	1950	2150
Diepte (mm)	1171	1171	1171	1171
Machine-apparatuur	×	×	×	×
Flexibele buis	Nee	Nee	Nee	Nee

Machine compatibiliteit				
All-Tach®	N51502545	N51502544	N51502543	N51502542
4 point Carriage	N51502613	N51502616	N51502618	N51502622
Euro Carriage	N51502572	N51502575	N51502577	N51502581
AL650	X	X	X	-
AL750	X	X	X	X
MLA 6-65 H-Z	X	X	X	-
MLA 7-75 H-Z	X	X	X	X

VERPLICHTE UITRUSTING VAN MACHINES : ×

KLEMMEN

Bereik



69 Balkenklem



BALKENKLEM

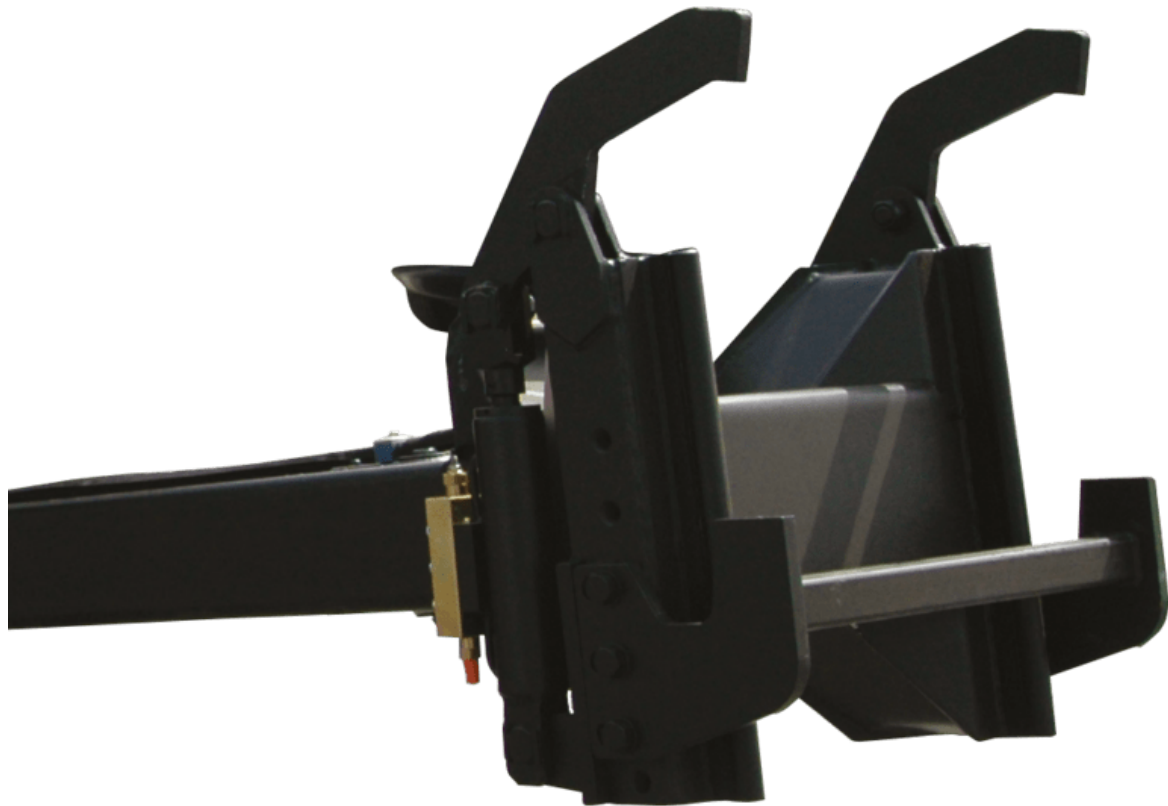

- Capaciteit 2000 kg of 4000 kg.
- Beweging van de hydraulische arm 45°.
- Manuele rotatie van de kop 65°/65°.
- Grote opening van de hydraulische knijper : minimale breedte 120 mm, max. 450 mm.
- Nota : de referentie 906734 is uitgerust met een cabine en een radiogestuurde bediening. Referentie 882008 enkel met bestuurbare cabine.
- Nota : aangepaste machineoptie vereist.

- Klem bestemd om gebintelementen te verhandelen en te plaatsen.
- Deze klem wordt gewaardeerd dankzij de hydraulische bewegingen van de arm en de manuele rotatie van de kop om zeer nauwkeurig te kunnen werken.
- Veiligheid: voorkomt dat de stukken blijven hangen in de vorken of de haken.
- Te bedienen vanuit de cabine of via een afstandsbediening.
- Nota : enkel om stukken met een verticale bevestiging te plaatsen. Deze stukken kunnen op de grond aangegrepen worden door de giek te laten kiepen.



	CLR 4000	PSC 40
Capaciteit (kg)	4000	4000
Gewicht (kg)	790	450
Lengte armen (mm)	1517	1517
Machine-apparatuur	☒☒	☒☒
Opening minimum (mm)	203	203
Opening maximum (mm)	480	480
Rotatie 1	45	45
Rotatie 2	130	130

Machine compatibiliteit		
Referentienummer E-RECO	52721819	923970
MRT 1645 75	X	X
MRT 1645 115	X	X
MRT 1845 75	X	X
MRT 1845 115	X	X
MRT 2145 115	X	X
MRT 2260	X	X
MRT 2260 e	X	-
MRT 2545 115	X	X
MRT 2570	X	X
MRT 2660	X	X
MRT 2660 e	X	-
MRT 3060	X	X
MRT 3570	X	X
MRT 3570 ES	X	X
MRT-X 1645	X	X
MRT-X 1845	X	X
MRT-X 2145	X	X
MRT-X 2260	X	X
MRT-X 2545	X	X
MRT-X 2570	X	X
MRT-X 2660	X	X
MRT-X 3060	X	X
MRT-X 3570	X	X
MRT-X 3570 ES	X	X
Referentienummer E-RECO 2	-	53027173
MRT 1645 75	-	X
MRT 1645 115	-	X
MRT 1845 75	-	X
MRT 1845 115	-	X
MRT 2145 115	-	X
MRT 2260	-	X
MRT 2545 115	-	X
MRT 2570	-	X
MRT 2660	-	X

	CLR 4000	PSC 40
Machine compatibiliteit		
MRT 3060	-	X
MRT 3570	-	X
MRT 3570 ES	-	X
MRT-X 1645	-	X
MRT-X 1845	-	X
MRT-X 2145	-	X
MRT-X 2260	-	X
MRT-X 2545	-	X
MRT-X 2570	-	X
MRT-X 2660	-	X
MRT-X 3060	-	X
MRT-X 3570	-	X
MRT-X 3570 ES	-	X

VERPLICHTE UITRUSTING VAN MACHINES : 

VORKDRAGERS

Bereik

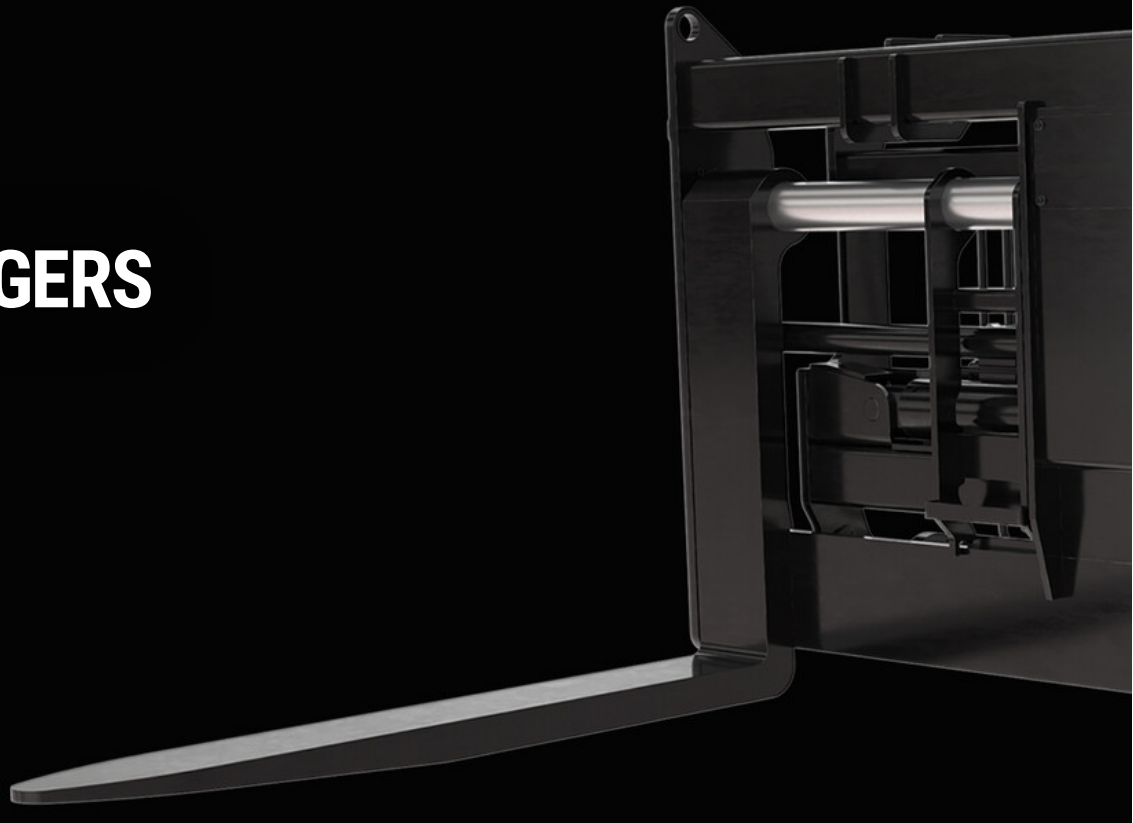

- 74 360° Roterend vorkenbord
- 76 Kantel- en zwenkbaar vorkenbord
- 78 Palletvorken compleet (compacte machines)
- 81 Rijtuig Drijvende Laadsteun En Vorken (MHT) **NEW**
- 84 Rijtuig Drijvende Laadsteun En Vorken (MRT) **NEW**
- 86 Rijtuig Drijvende Laadsteun En Vorken (MT - MLT) **NEW**
- 90 Vast vorkenbord
- 95 Vast vorkenbord (MRT - MHT) **NEW**
- 98 Vast vorkenbord met sideshift (MLT - MT)
- 101 Vast vorkenbord met sideshift (MRT - MHT) **NEW**
- 103 Verstelbare vorkschort met load backsplash (MLT - MT)
- 106 Vlottend vorkenbord (MLT - MT)
- 109 Vlottend vorkenbord met hydraulische schuinstelling
- 111 Vlottend vorkenbord met sideshift (MLT - MT) **NEW**
- 114 Vlottend vorkenbord met sideshift (MRT) **NEW**
- 116 Vorkversteller voor vlottende vorken
- 119 Zijdelingse kantelbare vorkdeur - Load backsplash (MLT - MT)









360° ROTEREND VORKENBORD



- Ononderbroken hydraulische rotatie.
- 2 capaciteiten : 4000 kg in front (+/- 15°) en 2500 kg in rotatie.
- CANBUS communicatie tussen het werktuig en de machine.
- Gemakkelijk verplaatsen van lange ladingen in beperkte ruimtes.
- Bespaart brandstof : het beperkt de bewegingen en manoeuvres van de machine.
- Veiligheid : een constante controle van het gewicht, de hoek en de positionering van de last in de ruimte; een flexibele overlastbeveiliging volgens de positie van de last.



	CAT 1200 / 4000 R	CAT 1200 / 5000 R
Capaciteit (kg)	4000	5000
Max. capaciteit vooraan (15°/15°) (kg)	4000	5000
Maximale capaciteit in rotatie (360°) (kg)	2500	2500
Gewicht (kg)	730	680
Totale hoogte (mm)	1193	1130
Totale lengte (mm)	2210	2208
Breedte (mm)	1290	1420
Machine-apparatuur	  + 	  + 
Minimum spreiding vorken (mm)	325	315
Maximum spreiding vorken (mm)	1200	1225
Rotatie 1	360	360

Beschikbare vorkafmetingen

125 x 50 x 1200	53026525	52629990
-----------------	----------	----------

Machine compatibiliteit

MRT 2260	X	X
MRT 2260 e	X	-
MRT 2570	X	X
MRT 2660	X	X
MRT 2660 e	X	-
MRT 3060	X	X
MRT 3570	X	X
MRT 3570 ES	X	X
MRT-X 2260	X	X
MRT-X 2570	X	X
MRT-X 2660	X	X
MRT-X 3060	X	X
MRT-X 3570	X	X
MRT-X 3570 ES	X	X

VERPLICHTE UITRUSTING VAN MACHINES :   + 



KANTEL- EN ZWENKBAAR VORKENBORD

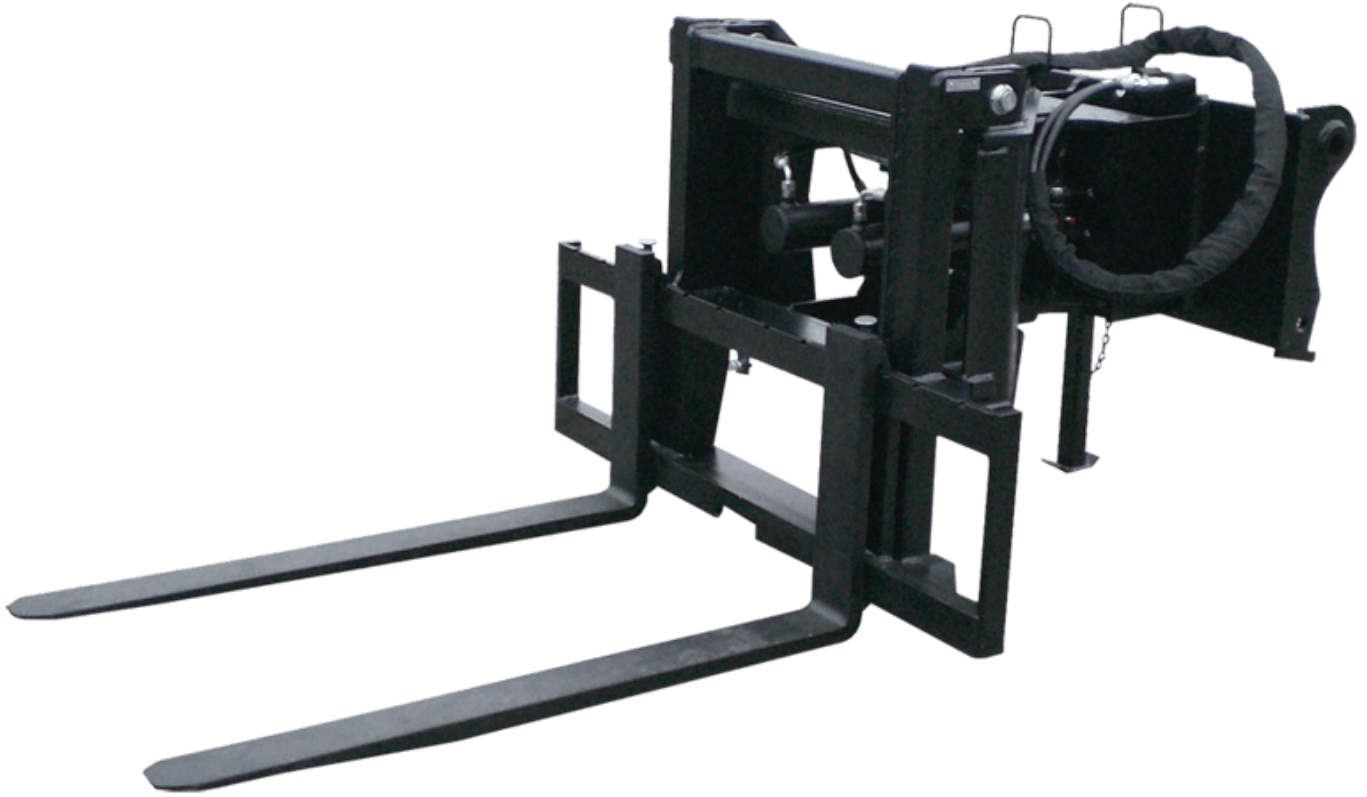

- Vorken FEM cat. 2.
- Hydraulische rotatie 90°/90°.
- Gebruik van beproefde Manitou componenten.
- Rotatie met 2 cilinders voor een verhoogde nauwkeurigheid.

UwtI4AEAAGgBWym1



	PFB 90° (h)
Capaciteit (kg)	1500
Gewicht (kg)	662
Totale hoogte (mm)	1008
Totale lengte (mm)	2432
Breedte (mm)	1360
Machine-apparatuur	
Rotatie 1	90
Rotatie 2	90

Beschikbare vorkafmetingen

100 x 45 x 1200	923348
-----------------	--------

Machine compatibiliteit

Referentienummer E-RECO	923348
MRT 2260	X
MRT 2260 e	X
MRT 2570	X
MRT 2660	X
MRT 2660 e	X
MRT 3060	X
MRT 3570	X
MRT 3570 ES	X
MRT-X 2260	X
MRT-X 2570	X
MRT-X 2660	X
MRT-X 3060	X
MRT-X 3570	X
MRT-X 3570 ES	X

VERPLICHTE UITRUSTING VAN MACHINES : 



PALLETVORKEN COMPLEET (COMPACTE MACHINES)



- Breed onderstel met achterbord voor meer stabiliteit tijdens verplaatsingen.
- Gestandaardiseerde FEM vorken met zijdelingse verstelling.
- Een all-round werktuig om paletten te verhandelen.

	CAT 915 / 800	CAT 920 / 1000	CAT 920 / 1100	CAT 920 / 1200	CAT 1200 / 1200
Capaciteit (kg)	800	1000	1100	1200	1200
Gewicht (kg)	115	-	-	-	160
Totale hoogte (mm)	893	893	893	893	888
Vorkgedeelte X Lengte vorken (mm)	35.10 X 800	1000	1100	1200	1200
Breedte (mm)	915	915	915	915	1212
Diepte (mm)	1260	1160	1260	1360	1488
Machine-apparatuur	×	×	×	×	×

Machine compatibiliteit					
All-Tach® Narrow	-	52807868	52807867	52799512	-
All-Tach®	-	N004019	-	-	-
4 point Carriage	-	52813313	52796388	52799521	-
Euro Carriage	-	52807866	52799511	-	-
850 R	X	-	-	-	-
AL420	-	X	X	X	-
AL430	-	X	X	X	-
AL650	-	-	-	-	X
AL750	-	-	-	-	X
MLA 2-25 H	-	X	-	-	-
MLA 3-25 H	-	X	-	-	-
MLA 3-25 H-C	-	X	-	-	-
MLA 4-50 H	-	-	X	X	-
MLA 4-50 H-C	-	-	X	X	-
MLA 6-65 H-Z	-	-	-	-	X
MLA 7-75 H-Z	-	-	-	-	X

	CAT 1210 / 1200 (b)	CAT 1220 / 1000 (a)	CAT 1220 / 1100 (a)	CAT 1220 / 1200 (a)
Capaciteit (kg)	1200	1000	1100	1200
Gewicht (kg)	183	152	160	165
Totale hoogte (mm)	890	890	890	890
Vorkgedeelte X Lengte vorken (mm)	1200	1000	1100	1200
Breedte (mm)	1212	1212	1212	1212
Diepte (mm)	1350	1318	1318	1318
Machine-apparatuur	×	×	×	×

Machine compatibiliteit				
All-Tach® Narrow	-	-	-	-
All-Tach®	52799516	-	-	-
4 point Carriage	52799513	-	-	-
Euro Carriage	52799514	-	-	-
1050 R	-	X	-	-
1050 RT	-	X	-	-
1350 R NXT2	-	X	-	-
1650 R	-	-	X	X
1650 RT	-	-	X	X
2700 V NXT:2	-	-	X	X
3300 V NXT:2	-	-	X	X
4200 V	-	-	X	X



NEW

RIJTUIG DRIJVENDE LAADSTEUN EN VORKEN (MHT)



- Lastrugleuning standaard.
- Vorkenverstelling.
- Vorkenvergrendeling mogelijk - bestel kit ref. 52675100.
- Opmerking: Verplichte verkeerskit in Italië. Neem contact op met uw dealer.
- Oplossing aangepast aan oneffen ondergrond : zwevende vorken + nivellering.

	CAF 1750 / 15 T	CAF 1750 / 16 T	CAF 1750 / 20 T	CAF 1750 / 12.5 T	CAF 2000 / 22 T	CAF 2000 / 25 T	CAF 2500 / 15 T
Capaciteit (kg)	15000	16000	20000	12500	22000	25000	15000
Totale hoogte (mm)	1604	1515	1604	1515	1624	1624	1605
Breedte (mm)	1750	1900	1750	1900	2140	2140	2500
Machine-apparatuur	×	×	×	×	×	×	×
Minimum spreiding vorken (mm)	455	520	455	560	1105	1045	1005
Maximum spreiding vorken (mm)	1605	1750	1605	1750	1970	1970	2355

Beschikbare vorkafmetingen

180 x 75 x 1200		52699113					
200 x 80 x 1200			52694204				
180 x 75 x 1500		52699114					
180 x 75 x 1800		52699115					
200 x 80 x 1800			52694205				
220 x 100 x 1800						52694547	
200 x 85 x 2400				52699116			
200 x 95 x 2400	52694206						52694209
250 x 100 x 2400					52694548		
200 x 95 x 3000							52694210

Machine compatibiliteit

MHT 10135 ST5	-	X	-	X	-	-	-
MHT 10160 ST5	-	X	-	X	-	-	-
MHT 10200 ST5	X	-	X	-	-	-	X
MHT 11250 ST5	-	-	-	-	X	X	-
MHT-X 10135 ST3A	-	X	-	X	-	-	-
MHT-X 10160 ST3A	-	X	-	X	-	-	-
MHT-X 10200 ST3A	X	-	X	-	-	-	X
MHT-X 11250 ST3A	-	-	-	-	X	X	-

VERPLICHTE UITRUSTING VAN MACHINES : ✕

	CAF 2500 / 16 T	CAF 2500 / 20 T	CAF 2500 / 22 T	CAF 2500 / 25 T	CAF 2500 / 12.5 T	TFF 9 T (a)	TFF 9 T (b)
Capaciteit (kg)	16000	20000	22000	25000	12500	9000	9000
Totale hoogte (mm)	1530	1524	1624	1624	1529	1405	1000
Breedte (mm)	2500	2500	2530	2530	2500	1585	2132
Machine-apparatuur	×	×	×	×	×	×	×
Minimum spreiding vorken (mm)	965	1005	1105	1045	1005	535	555
Maximum spreiding vorken (mm)	2365	2355	2360	2365	2365	1425	1995

Beschikbare vorkafmetingen

200 x 60 x 1200						939800	939347
180 x 75 x 1200	52700264						
200 x 80 x 1200		52694207					
200 x 60 x 1500						939345	939348
180 x 75 x 1500	52700265						
180 x 75 x 1800	52700266						
200 x 80 x 1800		52694208					
220 x 100 x 1800				52694549			
200 x 60 x 2000						939346	939349
200 x 85 x 2400					52700267		
250 x 100 x 2400			52694550				
250 x 100 x 3000			52694551				

Machine compatibiliteit

MHT 790 ST5	-	-	-	-	-	X	X
MHT 10135 ST5	X	-	-	-	X	-	-
MHT 10160 ST5	X	-	-	-	X	-	-
MHT 10200 ST5	-	X	-	-	-	-	-
MHT 11250 ST5	-	-	X	X	-	-	-
MHT-X 790 ST3A	-	-	-	-	-	X	X
MHT-X 10135 ST3A	X	-	-	-	X	-	-
MHT-X 10160 ST3A	X	-	-	-	X	-	-
MHT-X 10200 ST3A	-	X	-	-	-	-	-
MHT-X 11250 ST3A	-	-	X	X	-	-	-

VERPLICHTE UITRUSTING VAN MACHINES : ×



NEW

RIJTUIG DRIJVENDE LAADSTEUN EN VORKEN (MRT)



- Lastrugleuning standaard.
- Vorkenverstelling.
- Vorkenvergrendeling mogelijk - bestel kit ref. 52675100.
- Opmerking: Verplichte verkeerskit in Italië. Neem contact op met uw dealer.
- Opmerking: de verkeersset is in Duitsland verplicht op MRTs Vision/Vision+. Neem contact op met uw dealer.
- Oplossing aangepast aan oneffen ondergrond : zwevende vorken + nivellering.

	CAF 1030 / 6 T	CAF 1030 / 7 T	CAF 1030 / 4.5 T	CAF 1800 / 7 T	TFF 4.5 T
Capaciteit (kg)	6000	7000	4500	7000	4500
Totale hoogte (mm)	1009	1049	1280	1067	1280
Breedte (mm)	1110	1130	1127	1900	1127
Machine-apparatuur	×	×	×	×	×
Minimum spreiding vorken (mm)	500	598	215	598	265
Maximum spreiding vorken (mm)	1028	1028	1030	1798	1030

Beschikbare vorkafmetingen

125 x 50 x 1200					924857
100 x 60 x 1200	52658467		52721040		
125 x 60 x 1200		52676010		52701150	
100 x 60 x 1500	52719487				
125 x 60 x 1500		52719444		52719494	
100 x 60 x 1800	52719488				
125 x 60 x 1800		52719446		52719495	

Machine compatibiliteit

MRT 1645 75	-	-	X	-	X
MRT 1645 115	-	-	X	-	X
MRT 1845 75	-	-	X	-	X
MRT 1845 115	-	-	X	-	X
MRT 2145 115	-	-	X	-	X
MRT 2260	X	-	-	X	-
MRT 2260 e	X	-	-	X	-
MRT 2545 115	-	-	X	-	X
MRT 2570	-	X	-	X	-
MRT 2660	X	-	-	X	-
MRT 2660 e	X	-	-	X	-
MRT 3060	X	-	-	X	-
MRT 3570	-	X	-	X	-
MRT 3570 ES	-	X	-	X	-
MRT-X 1645	-	-	X	-	X
MRT-X 1845	-	-	X	-	X
MRT-X 2145	-	-	X	-	X
MRT-X 2260	X	-	-	X	-
MRT-X 2545	-	-	X	-	X
MRT-X 2570	-	X	-	X	-
MRT-X 2660	X	-	-	X	-
MRT-X 3060	X	-	-	X	-
MRT-X 3570	-	X	-	X	-
MRT-X 3570 ES	-	X	-	X	-

VERPLICHTE UITRUSTING VAN MACHINES : ✕



NEW

RIJTUIG DRIJVENDE LAADSTEUN EN VORKEN (MT - MLT)



- Lastrugleuning standaard.
- Vorkenverstelling.
- Vorkenvergrendeling mogelijk - bestel kit ref. 52675100.
- Opmerking: Verplichte verkeerskit in Italië. Neem contact op met uw dealer.
- Oplossing aangepast aan oneffen ondergrond : zwevende vorken + nivellering.



	CAF 1000 / 3 LB	CAF 1000 / 3 LB (b)	CAF 1000 / 1.5 LB	CAF 1000 / 4.1 LB
Capaciteit (kg)	3000	3000	1500	4100
Gewicht (kg)	240	254	175	306
Totale hoogte (mm)	989	989	1049	1036
Totale lengte (mm)	1359	1479	1384	1514
Breedte (mm)	1002	1002	1156	1160
Machine-apparatuur	×	×	×	×
Minimum spreiding vorken (mm)	244	284	160	493
Maximum spreiding vorken (mm)	924	924	927	1022

Beschikbare vorkafmetingen

100 x 50 x 1070	315452			
75 x 35 x 1100			52693600	
120 x 40 x 1200		52744200		
100 x 50 x 1200				52722290

Machine compatibiliteit

Referentienummer	52654990	52744200	-	-
All-Tach®	-	-	52693600	-
4 point Carriage	-	-	52723634	-
Euro Carriage	-	-	52723635	-
GCT 3-14	-	-	X	-
GCT 3-14 +	-	-	X	-
MLT 420-60 H	X	X	-	-
MLT 625-75 H	X	X	-	-
MLT 733-115	-	-	-	X
MLT 733-115 LSU	-	-	-	X
MLT 737-130 PS+	-	-	-	X
MLT 741-130 PS+	-	-	-	X
MLT 741-140 V+	-	-	-	X
MLT 841-145 PS+	-	-	-	X
MLT 940-140 V+	-	-	-	X
MLT 1041-145 PS+L	-	-	-	X
MLT-X 625-75 H	X	X	-	-
MLT-X 732	-	-	-	X
MLT-X 735 T LSU	-	-	-	X
MLT-X 735 T LSU (70 KW)	-	-	-	X
MLT-X 737-130 PS+	-	-	-	X
MLT-X 741-140 V+	-	-	-	X
MLT-X 841 - 145 PS+	-	-	-	X
MLT-X 1035 LT LSU	-	-	-	X
MLT-X 1041-145 PS+L	-	-	-	X
MT 420 H	X	X	-	-
MT 625 e	X	X	-	-
MT 625 HA	X	X	-	-
MT 730 H	X	X	-	-
MT 735 75D ST5	-	-	-	X

	CAF 1000 / 3 LB	CAF 1000 / 3 LB (b)	CAF 1000 / 1.5 LB	CAF 1000 / 4.1 LB
Machine compatibiliteit				
MT 930 H	X	X	-	-
MT 930 HA	X	X	-	-
MT 933 Easy	-	-	-	X
MT 935 75D ST5	-	-	-	X
MT 1033 easy	-	-	-	X
MT 1135 75 D	-	-	-	X
MT 1135 H 100D	-	-	-	X
MT 1135 easy ST5	-	-	-	X
MT 1135 H easy ST5	-	-	-	X
MT 1135 HA Easy ST5	-	-	-	X
MT 1135 ST5	-	-	-	X
MT 1335 75D ST5	-	-	-	X
MT 1335 100D ST5	-	-	-	X
MT 1335	-	-	-	X
MT 1335 easy ST5	-	-	-	X
MT 1335 H 75D ST5	-	-	-	X
MT 1335 H 100D ST5	-	-	-	X
MT 1335 H easy ST5	-	-	-	X
MT 1335 HA 75D ST5	-	-	-	X
MT 1335 HA 100D ST5	-	-	-	X
MT 1335 HA easy ST5	-	-	-	X
MT 1335 ST5	-	-	-	X
MT 1440 A	-	-	-	X
MT 1440 A ST5	-	-	-	X
MT 1440 easy ST5	-	-	-	X
MT 1440 HA	-	-	-	X
MT 1440 HA ST5	-	-	-	X
MT 1440 ST5	-	-	-	X
MT 1840 A 100D ST5 S1	-	-	-	X
MT 1840 A	-	-	-	X
MT 1840 easy ST5	-	-	-	X
MT 1840 HA	-	-	-	X
MT 1840 HA	-	-	-	X
MT 1840 ST5	-	-	-	X
MT-X 420 H	X	X	-	-
MT-X 625 H	X	X	-	-
MT-X 1033	-	-	-	X
MT-X 1440	-	-	-	X
MT-X 1440 A	-	-	-	X
MT-X 1840	-	-	-	X
MT-X 1840 A	-	-	-	X
ULM 412 H	-	-	X	-
ULM 412 H	-	-	X	-
ULM 415 H	-	-	X	-

CAF 1000 / 3 LB

CAF 1000 / 3 LB (b)

CAF 1000 / 1.5 LB

CAF 1000 / 4.1 LB

Machine compatibiliteit

ULM 415 H	-	-	X	-
-----------	---	---	---	---

VERPLICHTE UITRUSTING VAN MACHINES : ✕



VAST VORKENBORD



- Pendelende vorken.
- Vorken conform aan de FEM/ISO norm, lengte van de vorken afhankelijk van het model.
- De vorken zijn niet inbegrepen in de PFB, gelieve 2 vorken te bestellen (behalve voor CAT 1260/5T + F 150x50x1200).
- Een eenvoudige en efficiënte oplossing om goederen te vervoeren in ruw terrein

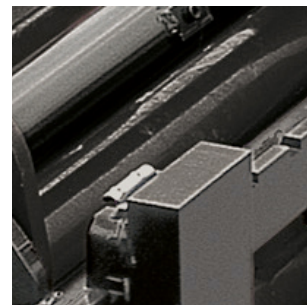

	CAT 1020 / 1.5 LB + 2 F 75x35x1100	CAT 1260 / 5 T + F 150x50x1200	PFB 20N 1020	PFB 25N 1020	PFB 25N 1260	PFB 35N 1260	PFB 35N 1470
Capaciteit (kg)	1500	5000	2000	2500	2500	3500	3500
Gewicht (kg)	137	406	166	71	80	93	117
Totale hoogte (mm)	695	677	582	-	-	-	-
Totale lengte (mm)	1372	1497	-	-	-	-	-
Breedte (mm)	1052	1302	1052	1026	1302	1302	1512
Machine-apparatuur	×	×	×	×	×	×	×
Minimum spreiding vorken (mm)	201	306	216	-	-	-	-
Maximum spreiding vorken (mm)	965	1150	980	-	-	-	-

Beschikbare vorkafmetingen

75 x 35 x 1100	52724830						
100 x 40 x 1200			415691				
125 x 45 x 1200				415835		415618	
150 x 50 x 1200		578097					

Machine compatibiliteit

Referentienummer	-	52735505	52558727	571958	571959	653744	653745
Referentievorkenbord schranklader	-	-	52000825	-	-	-	-
All-Tach®	52706271	-	-	-	-	-	-
4 point Carriage	52723636	-	-	-	-	-	-
Euro Carriage	52723637	-	-	-	-	-	-
ALT950	-	-	-	-	-	X	-
GCT 3-14	X	-	-	-	-	-	-
GCT 3-14 +	X	-	-	-	-	-	-
MLA-T 533-145 V+ - ST5	-	-	-	-	-	X	-
MLT 420-60 H	-	-	X	-	-	-	-
MLT 625-75 H	-	-	-	X	X	-	-
MLT 630-115	-	-	-	-	-	-	X
MLT 630-115 V	-	-	-	-	-	X	X
MLT 630-115 V CP	-	-	-	-	-	X	X
MLT 635-130 PS+	-	-	-	-	-	X	X
MLT 635-140 V+	-	-	-	-	-	X	X
MLT 730-115 V	-	-	-	-	-	X	X
MLT 730-115 V CP	-	-	-	-	-	X	X
MLT 733-115	-	-	-	-	-	X	X
MLT 733-115 LSU	-	-	-	-	-	X	X
MLT 850-145 V+	-	X	-	-	-	-	-
MLT-X 625-75 H	-	-	-	X	X	-	-
MLT-X 732	-	-	-	-	-	X	-
MLT-X 735 T LSU	-	-	-	-	-	X	X
MLT-X 850-145 V+	-	X	-	-	-	-	-
MLT-X 1035 LT LSU	-	-	-	-	-	X	X
MT 420 H	-	-	X	-	-	-	-
MT 625 e	-	-	-	X	X	-	-
MT 625 HA	-	-	-	X	X	-	-
MT 733 Easy	-	-	-	-	-	X	X

CAT 1020 / 1.5 LB + 2 F 75x35x1100	CAT 1260 / 5 T + F 150x50x1200	PFB 20N 1020	PFB 25N 1020	PFB 25N 1260	PFB 35N 1260	PFB 35N 1470
---------------------------------------	-----------------------------------	-----------------	-----------------	-----------------	-----------------	-----------------

Machine compatibiliteit						
MT 735 75D ST5	-	-	-	-	X	X
MT 933 Easy	-	-	-	-	X	X
MT 935 75D ST5	-	-	-	-	X	X
MT 1033 easy	-	-	-	-	X	X
MT 1135 75 D	-	-	-	-	X	X
MT 1135 H 100D	-	-	-	-	X	X
MT 1335 75D ST5	-	-	-	-	X	X
MT 1335 100D ST5	-	-	-	-	X	X
MT 1335	-	-	-	-	X	X
MT 1335 H 75D ST5	-	-	-	-	X	X
MT 1335 H 100D ST5	-	-	-	-	X	X
MT 1335 HA 75D ST5	-	-	-	-	X	X
MT 1335 HA 100D ST5	-	-	-	-	X	X
MT-X 420 H	-	-	X	-	-	-
MT-X 625 H	-	-	-	X	X	-
MT-X 733 Mining	-	-	-	-	X	X
MT-X 1033 Mining	-	-	-	-	X	X
MT-X 1033 A Mining	-	-	-	-	X	X
ULM 412 H	X	-	-	-	-	-
ULM 412 H	X	-	-	-	-	-
ULM 415 H	X	-	-	-	-	-
ULM 415 H	X	-	-	-	-	-

VERPLICHTE UITRUSTING VAN MACHINES : ✕

	PFB 35N 1580	PFB 45N 1260	PFB 45N 1670	PFB 45N 2000	PFB 75MT 1750	PFB 75MT 2000	PFB FEM4 1200
Capaciteit (kg)	3500	4500	4500	4500	7500	7500	6000
Gewicht (kg)	122	198	252	295	-	-	-
Totale hoogte (mm)	-	-	-	-	-	-	-
Totale lengte (mm)	-	-	-	-	-	-	-
Breedte (mm)	1622	1286	1696	2026	1834	2084	1200
Machine-apparaat	×	×	×	×	×	×	×
Minimum spreiding vorken (mm)	-	-	-	-	-	-	-
Maximum spreiding vorken (mm)	-	-	-	-	-	-	-

Beschikbare vorkafmetingen

125 x 50 x 1200		415652		615652			
200 x 60 x 1200							513110

Machine compatibiliteit

Referentienummer	653746	654407	653747	653748	504107	527216	732330
Referentievorkenbord schranklader	-	-	-	-	-	-	-
All-Tach®	-	-	-	-	-	-	-
4 point Carriage	-	-	-	-	-	-	-
Euro Carriage	-	-	-	-	-	-	-
MLT 630-115	X	-	-	-	-	-	-
MLT 630-115 V	X	-	-	-	-	-	-
MLT 630-115 V CP	X	-	-	-	-	-	-
MLT 635-130 PS+	X	-	-	-	-	-	-
MLT 635-140 V+	X	-	-	-	-	-	-
MLT 730-115 V	X	-	-	-	-	-	-
MLT 730-115 V CP	X	-	-	-	-	-	-
MLT 733-115	X	-	-	-	-	-	-
MLT 733-115 LSU	X	-	-	-	-	-	-
MLT 737-130 PS+	-	-	X	X	-	-	-
MLT 741-130 PS+	-	X	X	X	-	-	-
MLT 741-140 V+	-	X	X	X	-	-	-
MLT 841-145 PS+	-	X	X	-	-	-	-
MLT 940-140 V+	-	-	X	X	-	-	-
MLT 961-160 V+ L	-	-	-	-	X	X	X
MLT 1041-145 PS+L	-	X	X	-	-	-	-
MLT-X 735 T LSU	X	-	-	-	-	-	-
MLT-X 737-130 PS+	-	-	X	X	-	-	-
MLT-X 741-140 V+	-	X	X	X	-	-	-
MLT-X 741 T LSU	-	X	X	-	-	-	-
MLT-X 841 - 145 PS+	-	X	X	-	-	-	-
MLT-X 961-160 V+ L	-	-	-	-	X	X	X
MLT-X 1035 LT LSU	X	-	-	-	-	-	-
MLT-X 1041-145 PS+L	-	X	X	-	-	-	-
MT 733 Easy	X	-	-	-	-	-	-
MT 735 75D ST5	X	-	-	-	-	-	-
MT 933 Easy	X	-	-	-	-	-	-

PFB 35N 1580 PFB 45N 1260 PFB 45N 1670 PFB 45N 2000 PFB 75MT 1750 PFB 75MT 2000 PFB FEM4 1200

Machine compatibiliteit							
MT 935 75D ST5	X	-	-	-	-	-	-
MT 1033 easy	X	-	-	-	-	-	-
MT 1135 75 D	X	-	-	-	-	-	-
MT 1135 H 100D	X	-	-	-	-	-	-
MT 1335 75D ST5	X	-	-	-	-	-	-
MT 1335 100D ST5	X	-	-	-	-	-	-
MT 1335 H 75D ST5	X	-	-	-	-	-	-
MT 1335 H 100D ST5	X	-	-	-	-	-	-
MT 1335 HA 75D ST5	X	-	-	-	-	-	-
MT 1335 HA 100D ST5	X	-	-	-	-	-	-
MT 1440 A ST5	-	X	-	X	-	-	-
MT 1440 easy ST5	-	X	-	X	-	-	-
MT 1440 HA ST5	-	X	-	X	-	-	-
MT 1440 ST5	-	X	-	X	-	-	-
MT 1840 A 100D ST5 S1	-	X	-	X	-	-	-
MT 1840 easy ST5	-	X	-	X	-	-	-
MT 1840 HA	-	X	-	X	-	-	-
MT 1840 ST5	-	X	-	X	-	-	-
MT-X 733 Mining	X	-	-	-	-	-	-
MT-X 1033 Mining	X	-	-	-	-	-	-
MT-X 1033 A Mining	X	-	-	-	-	-	-
MT-X 1440	-	X	X	X	-	-	-
MT-X 1440 A	-	X	X	X	-	-	-
MT-X 1840	-	X	X	X	-	-	-
MT-X 1840 A	-	X	X	X	-	-	-

VERPLICHTE UITRUSTING VAN MACHINES : ✕



NEW

VAST VORKENBORD (MRT - MHT)



- Pendelende vorken.
- Vorken conform aan de FEM norm, lengte van de vorken afhankelijk van het model.
- Opmerking: Verplichte verkeerskit in Italië. Neem contact op met uw dealer.
- Opmerking: de verkeersset is in Duitsland verplicht op MRTs Vision/Vision+. Neem contact op met uw dealer.
- Een eenvoudige en efficiënte oplossing om goederen te vervoeren.

	CAT 1320 / 6 T (a)	CAT 1320 / 7 T (a)	CAT 1750 / 5 T (a)	CAT 1750 / 7 T (a)	CAT 1750 / 2.5 T	CAT 2000 / 5 T (a)
Capaciteit (kg)	6000	7000	5000	7000	2500	5000
Totale hoogte (mm)	965	965	819	950	820	819
Breedte (mm)	1404	1404	1834	1834	1834	2084
Machine-apparatuur	×	×	×	×	×	×
Minimum spreiding vorken (mm)	320	370	482	370	482	482
Maximum spreiding vorken (mm)	1200	1250	1698	1690	1698	1850

Beschikbare vorkafmetingen

150 x 50 x 1200			52721175			52721208
100 x 60 x 1200	52718348					
150 x 60 x 1200		52655420		52655520		
150 x 50 x 1500			52721176			52721209
100 x 60 x 1500	52718356					
150 x 60 x 1500		52718373		52718375		
100 x 60 x 1800	52718357					
150 x 60 x 1800		52718374		52718377		
150 x 50 x 2000					52721177	52721210

Machine compatibiliteit

MRT 1645 75	-	-	X	-	X	X
MRT 1645 115	-	-	X	-	X	X
MRT 1845 75	-	-	X	-	X	X
MRT 1845 115	-	-	X	-	X	X
MRT 2145 115	-	-	X	-	X	X
MRT 2260	X	-	-	X	-	-
MRT 2260 e	X	-	-	X	-	-
MRT 2545 115	-	-	X	-	X	X
MRT 2570	-	X	-	X	-	-
MRT 2660	X	-	-	X	-	-
MRT 2660 e	X	-	-	X	-	-
MRT 3060	X	-	-	X	-	-
MRT 3570	-	X	-	X	-	-
MRT 3570 ES	-	X	-	X	-	-
MRT-X 1645	-	-	X	-	X	X
MRT-X 1845	-	-	X	-	X	X
MRT-X 2145	-	-	X	-	X	X
MRT-X 2260	X	-	-	X	-	-
MRT-X 2545	-	-	X	-	X	X
MRT-X 2570	-	X	-	X	-	-
MRT-X 2660	X	-	-	X	-	-
MRT-X 3060	X	-	-	X	-	-
MRT-X 3570	-	X	-	X	-	-
MRT-X 3570 ES	-	X	-	X	-	-

VERPLICHTE UITRUSTING VAN MACHINES : ×

	CAT 2000 / 7 T (a)	PFB 1320 (c4.5)	PFB 1320 (c4.5b)	PFB 1750 (c9)	PFB 2000 (c9)
Capaciteit (kg)	7000	4500	4500	9000	9000
Totale hoogte (mm)	965	818	819	832	832
Breedte (mm)	2084	1404	1404	1834	2084
Machine-apparatuur	×	×	×	×	×
Minimum spreiding vorken (mm)	370	458	480	420	420
Maximum spreiding vorken (mm)	1930	1125	1242	1730	1980

Beschikbare vorkafmetingen

125 x 50 x 1200		924877			
150 x 60 x 1200	52655525				
200 x 60 x 1200				939056	939058
150 x 60 x 1500	52718378				
200 x 60 x 1500				53021960	53022163
150 x 50 x 1800			52601398		
150 x 60 x 1800	52718379				
200 x 60 x 2000				53025302	53025305

Machine compatibiliteit

MHT 790 ST5	-	-	-	X	X
MHT-X 790 Mining	-	-	-	X	X
MHT-X 790 ST3A	-	-	-	X	X
MRT 1645 75	-	X	X	-	-
MRT 1645 115	-	X	X	-	-
MRT 1845 75	-	X	X	-	-
MRT 1845 115	-	X	X	-	-
MRT 2145 115	-	X	X	-	-
MRT 2260	X	-	-	-	-
MRT 2260 e	X	-	-	-	-
MRT 2545 115	-	X	X	-	-
MRT 2570	X	-	-	-	-
MRT 2660	X	-	-	-	-
MRT 2660 e	X	-	-	-	-
MRT 3060	X	-	-	-	-
MRT 3570	X	-	-	-	-
MRT 3570 ES	X	-	-	-	-
MRT-X 1645	-	X	X	-	-
MRT-X 1845	-	X	X	-	-
MRT-X 2145	-	X	X	-	-
MRT-X 2260	X	-	-	-	-
MRT-X 2545	-	X	X	-	-
MRT-X 2570	X	-	-	-	-
MRT-X 2660	X	-	-	-	-
MRT-X 3060	X	-	-	-	-
MRT-X 3570	X	-	-	-	-
MRT-X 3570 ES	X	-	-	-	-





VERPLICHTE UITRUSTING VAN MACHINES : ×

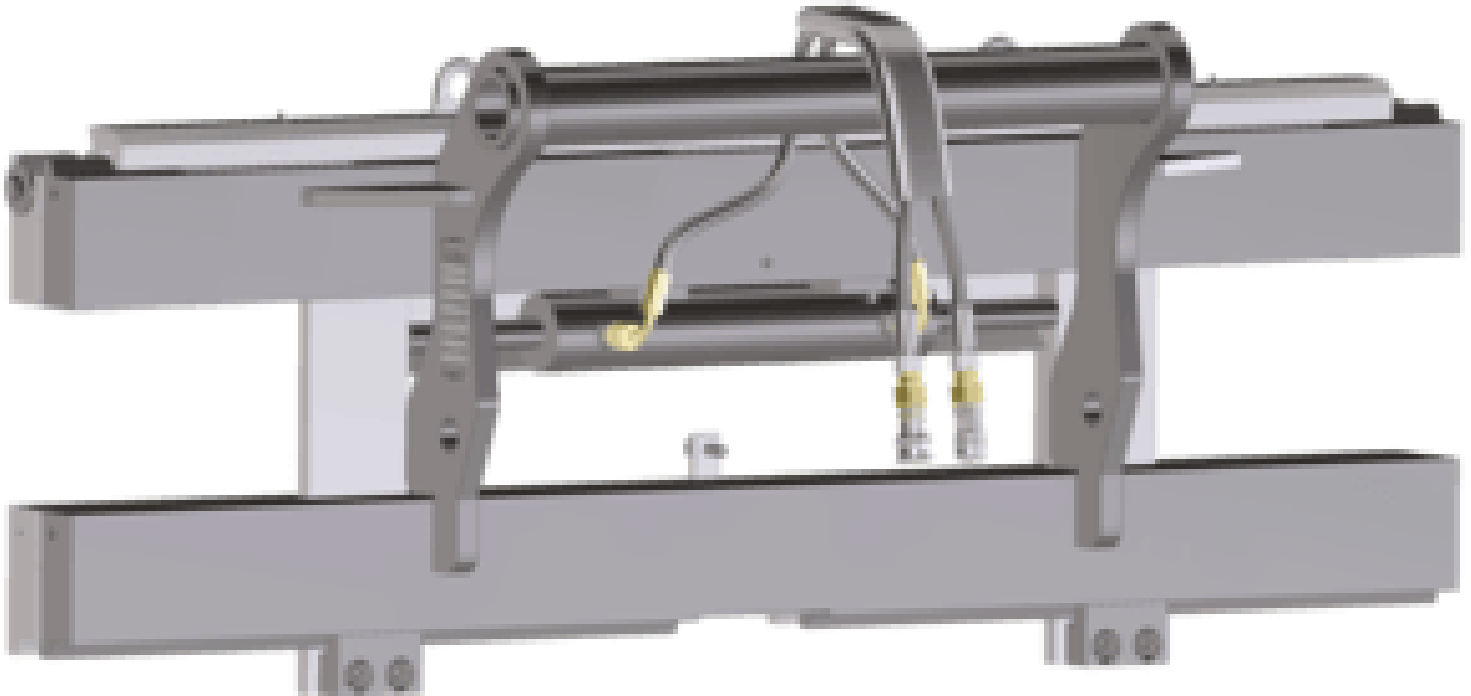

VAST VORKENBORD MET SIDESHIFT (MLT - MT)



- Hydraulische leiding vereist om vorkbeweging vanuit de cabine mogelijk te maken.
- Kantelbare vorken.
- Vorken volgens FEM/ISO-norm, vorklengte afhankelijk van model.
- Vorken zijn niet inbegrepen in PFB's, bestel 2 eenheden (behalve CAT 1260 / 5T SS + F 150x50x1200).

	PFB 25N 1020 SS	PFB 25N 1260 SS	PFB 35N 1260 SS	PFB 35N 1580 SS	PFB 45N 1670 SS
Capaciteit (kg)	2500	2500	3500	3500	4500
Gewicht (kg)	135	145	175	300	540
Totale hoogte (mm)	553	554	658	658	666
Breedte (mm)	1020	1260	1260	1580	1670
Machine-apparatuur					
Zijverschuiving (mm)	100	100	100	100	100

Beschikbare vorkafmetingen

125 x 45 x 1200	52000099	52000100	52000101	52000102	
125 x 50 x 1200					52000103

Machine compatibiliteit

MLT 625-75 H	X	X	-	-	-
MLT 733-115	-	-	X	-	-
MLT 733-115 LSU	-	-	X	-	-
MLT-X 625-75 H	X	X	-	-	-
MT 625 e	X	X	-	-	-
MT 625 HA	X	X	-	-	-
MT 733 Easy	-	-	X	X	-
MT 735 75D ST5	-	-	X	X	-
MT 933 Easy	-	-	X	X	-
MT 935 75D ST5	-	-	X	X	-
MT 1033 easy	-	-	X	X	-
MT 1135 75 D	-	-	X	X	-
MT 1135 H 100D	-	-	X	X	-
MT 1135 easy ST5	-	-	X	X	-
MT 1135 H easy ST5	-	-	X	X	-
MT 1135 HA Easy ST5	-	-	X	X	-
MT 1135 ST5	-	-	X	X	-
MT 1335 75D ST5	-	-	X	X	-
MT 1335 100D ST5	-	-	X	X	-
MT 1335	-	-	X	X	-
MT 1335 easy ST5	-	-	X	X	-
MT 1335 H 75D ST5	-	-	X	X	-
MT 1335 H 100D ST5	-	-	X	X	-
MT 1335 H easy ST5	-	-	X	X	-
MT 1335 HA 75D ST5	-	-	X	X	-
MT 1335 HA 100D ST5	-	-	X	X	-
MT 1335 HA easy ST5	-	-	X	X	-
MT 1335 ST5	-	-	X	X	-
MT 1440 A	-	-	-	-	X
MT 1440 A ST5	-	-	-	-	X
MT 1440 easy ST5	-	-	-	-	X
MT 1440 HA	-	-	-	-	X
MT 1440 HA ST5	-	-	-	-	X
MT 1440 ST5	-	-	-	-	X

PFB 25N 1020 SS

PFB 25N 1260 SS

PFB 35N 1260 SS

PFB 35N 1580 SS

PFB 45N 1670 SS

Machine compatibiliteit

	PFB 25N 1020 SS	PFB 25N 1260 SS	PFB 35N 1260 SS	PFB 35N 1580 SS	PFB 45N 1670 SS
MT 1840 A 100D ST5 S1	-	-	-	-	X
MT 1840 A	-	-	-	-	X
MT 1840 easy ST5	-	-	-	-	X
MT 1840 HA	-	-	-	-	X
MT 1840 HA	-	-	-	-	X
MT 1840 ST5	-	-	-	-	X
MT-X 625 H	X	X	-	-	-
MT-X 733	-	-	X	X	-
MT-X 1033	-	-	X	X	-
MT-X 1440	-	-	-	-	X
MT-X 1440 A	-	-	-	-	X
MT-X 1840	-	-	-	-	X
MT-X 1840 A	-	-	-	-	X

VERPLICHTE UITRUSTING VAN MACHINES : 









NEW

VAST VORKENBORD MET SIDESHIFT (MRT - MHT)



- Pendelende vorken.
- Vorken conform aan de FEM norm, lengte van de vorken afhankelijk van het model.
- Constante zijdelingse verschuiving.
- Opmerking: Verplichte verkeerskit in Italië. Neem contact op met uw dealer.
- Opmerking: de verkeersset is in Duitsland verplicht op MRTs Vision/Vision+. Neem contact op met uw dealer.
- Een eenvoudige en efficiënte oplossing om goederen te vervoeren.



	CAT 2000 / 7 T (a)	PFB 1320 (c4.5)	PFB 1320 (c4.5b)	PFB 1320 (c4.9-a)	PFB 1750 (c9)	PFB 2000 (c9)
Capaciteit (kg)	7000	4500	4500	4999	9000	9000
Totale hoogte (mm)	1000	819	821	821	832	875
Breedte (mm)	2000	1404	1406	1406	1834	1990
Machine-apparatuur						
Zijverschuiving (mm)	100	100	100	100	100	100
Minimum spreiding vorken (mm)	417	482	392	417	467	-
Maximum spreiding vorken (mm)	1839	1242	1292	1317	1640	1890

Beschikbare vorkafmetingen

125 x 50 x 1200			924878			
150 x 50 x 1200				921241		
150 x 60 x 1200	52712870					
200 x 60 x 1200					939057	939059
150 x 50 x 1500		921525		921513		
150 x 60 x 1500	52719378					
200 x 60 x 1500					53025304	53025306
150 x 50 x 2000				921514		
150 x 60 x 2000	52719379					
200 x 60 x 2000					53025303	53025307

Machine compatibiliteit

MHT 790 ST5	-	-	-	-	X	X
MHT-X 790 Mining	-	-	-	-	X	X
MHT-X 790 ST3A	-	-	-	-	X	X
MRT 1645 75	-	X	X	-	-	-
MRT 1645 115	-	X	X	-	-	-
MRT 1845 75	-	X	X	-	-	-
MRT 1845 115	-	X	X	-	-	-
MRT 2145 115	-	X	X	-	-	-
MRT 2260	X	-	X	X	-	-
MRT 2545 115	-	X	X	-	-	-
MRT 2570	X	-	X	X	-	-
MRT 2660	X	-	X	X	-	-
MRT 3060	X	-	X	X	-	-
MRT 3570	X	-	X	X	-	-
MRT 3570 ES	X	-	X	X	-	-
MRT-X 1645	-	X	X	-	-	-
MRT-X 1845	-	X	X	-	-	-
MRT-X 2145	-	X	X	-	-	-
MRT-X 2260	X	-	X	X	-	-
MRT-X 2545	-	X	X	-	-	-
MRT-X 2570	X	-	X	X	-	-
MRT-X 2660	X	-	X	X	-	-
MRT-X 3060	X	-	X	X	-	-
MRT-X 3570	X	-	X	X	-	-

VERPLICHTE UITRUSTING VAN MACHINES : 



VERSTELBARE VORKSCHORT MET LOAD BACKSPLASH (MLT - MT)



- Load splash vastgeschroefd aan het "PFB" schort.
- Opmerking: moet worden gebruikt met FEM-vorken.

	PFB 25N 1020 LB	PFB 25N 1260 LB	PFB 35N 1260 LB	PFB 35N 1470 LB	PFB 45N 1670 LB	PFB 45N 2000 LB
Capaciteit (kg)	2500	2500	3500	3500	4500	4500
Gewicht (kg)	105	118	130	158	310	360
Totale hoogte (mm)	1176	1188	1185	1185	1209	1209
Breedte (mm)	1044	1284	1284	1494	1810	2140
Machine-apparatuur	×	×	×	×	×	×

Beschikbare vorkafmetingen

125 x 45 x 1200	52000198	52000199	52000200	52000201		
125 x 50 x 1200					52000202	52000203

Machine compatibiliteit

ALT950	-	-	X	-	-	-
MLA-T 533-145 V+ - ST5	-	-	X	-	-	-
MLT 625-75 H	X	X	-	-	-	-
MLT 630-115	-	-	X	X	-	-
MLT 630-115 V	-	-	X	X	-	-
MLT 630-115 V CP	-	-	X	X	-	-
MLT 635-130 PS+	-	-	X	X	-	-
MLT 635-140 V+	-	-	X	X	-	-
MLT 730-115 V	-	-	X	X	-	-
MLT 730-115 V CP	-	-	X	X	-	-
MLT 733-115	-	-	X	X	-	-
MLT 733-115 LSU	-	-	X	X	-	-
MLT 737-130 PS+	-	-	-	-	X	X
MLT 741-130 PS+	-	-	-	-	X	X
MLT 741-140 V+	-	-	-	-	X	X
MLT 841-145 PS+	-	-	-	-	X	X
MLT 940-140 V+	-	-	-	-	X	X
MLT 961-160 V+ L	-	-	-	-	X	X
MLT 1041-145 PS+L	-	-	-	-	X	X
MLT-X 625-75 H	X	X	-	-	-	-
MLT-X 735 T LSU	-	-	X	X	-	-
MLT-X 735 T LSU (70 KW)	-	-	X	X	-	-
MLT-X 737-130 PS+	-	-	-	-	X	X
MLT-X 741-140 V+	-	-	-	-	X	X
MLT-X 841 - 145 PS+	-	-	-	-	X	X
MLT-X 961-160 V+ L	-	-	-	-	X	X
MLT-X 1041-145 PS+L	-	-	-	-	X	X
MT 625 e	X	-	-	-	-	-
MT 625 HA	X	-	-	-	-	-
MT 733 Easy	-	-	X	X	-	-
MT 735 75D ST5	-	-	X	X	-	-
MT 933 Easy	-	-	X	X	-	-
MT 935 75D ST5	-	-	X	X	-	-
MT 1033 easy	-	-	X	X	-	-
MT 1135 75 D	-	-	X	X	-	-

PFB 25N 1020 LB	PFB 25N 1260 LB	PFB 35N 1260 LB	PFB 35N 1470 LB	PFB 45N 1670 LB	PFB 45N 2000 LB
-----------------	-----------------	-----------------	-----------------	-----------------	-----------------

Machine compatibiliteit						
MT 1135 H 100D	-	-	X	X	-	-
MT 1135 easy ST5	-	-	X	X	-	-
MT 1135 H easy ST5	-	-	X	X	-	-
MT 1135 HA Easy ST5	-	-	X	X	-	-
MT 1135 ST5	-	-	X	X	-	-
MT 1335 75D ST5	-	-	X	X	-	-
MT 1335 100D ST5	-	-	X	X	-	-
MT 1335	-	-	X	X	-	-
MT 1335 easy ST5	-	-	X	X	-	-
MT 1335 H 75D ST5	-	-	X	X	-	-
MT 1335 H 100D ST5	-	-	X	X	-	-
MT 1335 H easy ST5	-	-	X	X	-	-
MT 1335 HA 75D ST5	-	-	X	X	-	-
MT 1335 HA 100D ST5	-	-	X	X	-	-
MT 1335 HA easy ST5	-	-	X	X	-	-
MT 1335 ST5	-	-	X	X	-	-
MT 1440 A	-	-	-	-	X	X
MT 1440 A ST5	-	-	-	-	X	X
MT 1440 easy ST5	-	-	-	-	-	X
MT 1440 HA	-	-	-	-	X	X
MT 1440 HA ST5	-	-	-	-	X	X
MT 1440 ST5	-	-	-	-	X	X
MT 1840 A 100D ST5 S1	-	-	-	-	X	X
MT 1840 A	-	-	-	-	X	X
MT 1840 easy ST5	-	-	-	-	-	X
MT 1840 HA	-	-	-	-	X	X
MT 1840 HA	-	-	-	-	X	X
MT 1840 ST5	-	-	-	-	X	X
MT-X 625 H	X	-	-	-	-	-
MT-X 733	-	-	X	X	-	-
MT-X 1033	-	-	X	X	-	-
MT-X 1440	-	-	-	-	X	X
MT-X 1440 A	-	-	-	-	X	X
MT-X 1840	-	-	-	-	X	X
MT-X 1840 A	-	-	-	-	X	X

VERPLICHTE UITRUSTING VAN MACHINES : ✕



VLOTTEND VORKENBORD (MLT - MT)



- Lastrugleuning standaard.
- Vorkenverstelling.
- Oplossing aangepast aan oneffen ondergrond : zwevende vorken + nivellering.

	TFF 35 MT (a)	TFF 35 MT (c)	TFF 35 MT (UK)	TFF 45 MT (a)	TFF 45 MT (c)	TFF 75 MT
Capaciteit (kg)	3500	3500	3500	4500	4500	7500
Breedte (mm)	1140	1400	1140	1160	1420	1495
Machine-apparatuur	×	×	×	×	×	×
Maximum spreiding vorken (mm)	1040	1300	1040	1040	1300	1430

Beschikbare vorkafmetingen

125 x 45 x 1200	654093	654094				
100 x 50 x 1200			788793	788794		
125 x 50 x 1200				653344	653345	
200 x 60 x 1200						528083
200 x 60 x 1500						578154

Machine compatibiliteit

Referentienummer	-	-	-	-	-	504280
MLT 630-115	X	X	-	-	-	-
MLT 630-115 V	X	X	-	-	-	-
MLT 630-115 V CP	X	X	-	-	-	-
MLT 635-130 PS+	X	X	-	-	-	-
MLT 635-140 V+	-	X	-	-	-	-
MLT 730-115 V	X	X	-	-	-	-
MLT 730-115 V CP	X	X	-	-	-	-
MLT 733-115	X	X	-	-	-	-
MLT 733-115 LSU	-	X	-	-	-	-
MLT 737-130 PS+	-	-	-	X	X	-
MLT 741-130 PS+	-	-	-	X	X	-
MLT 741-140 V+	-	-	-	X	X	-
MLT 841-145 PS+	-	-	-	X	X	-
MLT 850-145 V+	-	-	-	-	-	X
MLT 940-140 V+	-	-	-	X	X	-
MLT 961-160 V+ L	-	-	-	-	-	X
MLT 1041-145 PS+L	-	-	-	X	X	-
MLT-X 732	X	-	-	-	-	-
MLT-X 735 T LSU	X	X	-	-	-	-
MLT-X 735 T LSU (70 kW)	X	-	-	-	-	-
MLT-X 737-130 PS+	-	-	-	X	X	-
MLT-X 741-140 V+	-	-	-	X	X	-
MLT-X 841 - 145 PS+	-	-	-	X	X	-
MLT-X 850-145 V+	-	-	-	-	-	X
MLT-X 961-160 V+ L	-	-	-	-	-	X
MLT-X 1035 LT LSU	X	X	-	X	-	-
MLT-X 1041-145 PS+L	-	-	-	X	X	-
MT 733 Easy	X	X	X	-	-	-
MT 933 Easy	X	X	X	-	-	-
MT 1033 easy	X	X	X	-	-	-
MT 1135 easy ST5	X	X	X	-	-	-
MT 1135 H easy ST5	X	X	X	-	-	-

TFF 35 MT (a)	TFF 35 MT (c)	TFF 35 MT (UK)	TFF 45 MT (a)	TFF 45 MT (c)	TFF 75 MT
---------------	---------------	----------------	---------------	---------------	-----------

Machine compatibiliteit						
MT 1135 HA Easy ST5	X	X	X	-	-	-
MT 1135 ST5	X	X	X	-	-	-
MT 1335	X	X	X	-	-	-
MT 1335 easy ST5	X	X	X	-	-	-
MT 1335 H easy ST5	X	X	X	-	-	-
MT 1335 HA easy ST5	-	X	X	-	-	-
MT 1335 ST5	X	X	-	-	-	-
MT 1440 A	-	-	-	X	X	-
MT 1440 A ST5	-	-	-	X	X	-
MT 1440 easy ST5	-	-	-	X	X	-
MT 1440 HA	-	-	-	X	X	-
MT 1440 HA ST5	-	-	-	X	X	-
MT 1440 ST5	-	-	-	X	X	-
MT 1840 A 100D ST5 S1	-	-	-	X	X	-
MT 1840 A	-	-	-	X	X	-
MT 1840 easy ST5	-	-	-	X	X	-
MT 1840 HA	-	-	-	X	X	-
MT 1840 HA	-	-	-	X	X	-
MT 1840 ST5	-	-	-	X	X	-
MT-X 733	X	X	X	-	-	-
MT-X 1033	X	X	X	-	-	-
MT-X 1440	-	-	-	-	X	-
MT-X 1440 A	-	-	-	-	X	-
MT-X 1840	-	-	-	-	X	-
MT-X 1840 A	-	-	-	-	X	-



VERPLICHTE UITRUSTING VAN MACHINES : ✕



VLOTTEND VORKENBORD MET HYDRAULISCHE SCHUINSTELLING



- Hydraulische niveaucorrectie 10°/10°.
- Vorken met oog 150 x 60 x 1200 mm.
- Capaciteit 4,9t.
- Max. afstand van de vorken 1180 mm (buitenkant van de vorken).
- Gewicht (765 kg) & dikte (280 mm).
- Converte o seu empilhador telescópico num guindaste.
- Acoplamento extremamente rápido no empilhador MANITOU.
- Controlo fácil da direção desde a cabine ou com o controlo remoto da máquina (opcional).
- Movimentos rápidos e precisos.

	TFF 1230 + Levelling (a)	TFF 1230 + Levelling (b)
Capaciteit (kg)	4900	4900
Gewicht (kg)	617	765
Totale hoogte (mm)	1420	1420
Totale lengte (mm)	1545	1555
Breedte (mm)	1311	1311
Machine-apparatuur		
Maximum spreiding vorken (mm)	1010	1010

Beschikbare vorkafmetingen		
125 x 50 x 1200	924876	
150 x 60 x 1200		921240

Machine compatibiliteit		
MRT 1645 75	X	-
MRT 1645 115	X	-
MRT 1845 75	X	-
MRT 1845 115	X	-
MRT 2145 115	X	-
MRT 2260	-	X
MRT 2260 e	-	X
MRT 2545 115	X	-
MRT 2570	-	X
MRT 2660	-	X
MRT 2660 e	-	X
MRT 3060	-	X
MRT 3570	-	X
MRT 3570 ES	-	X
MRT-X 1645	X	-
MRT-X 1845	X	-
MRT-X 2145	X	-
MRT-X 2260	-	X
MRT-X 2545	X	-
MRT-X 2570	-	X
MRT-X 2660	-	X
MRT-X 3060	-	X
MRT-X 3570	-	X
MRT-X 3570 ES	-	X

VERPLICHTE UITRUSTING VAN MACHINES : 



NEW

VLOTTEND VORKENBORD MET SIDESHIFT (MLT - MT)



- Hydraulic line required to allow fork movement from the cab.
- Pin type forks.
- Bolt-on load backrest for a better longevity.

	TFF 29 DL 1040	TFF 35 DL 1040	TFF 35 DL 1300	TFF 45 DL 1040	TFF 45 DL 1300
Capaciteit (kg)	2900	3500	3500	4500	4500
Breedte (mm)	1040	1040	1300	1040	1300
Machine-apparatuur	☺☺	☺☺	☺☺	☺☺	☺☺

Beschikbare vorkafmetingen

120 x 40 x 1200	751378				
125 x 45 x 1200		751543	751544		
125 x 50 x 1200				751545	751546

Machine compatibiliteit

MT 730 H	-	X	-	-	-
MT 733 Easy	-	X	-	-	-
MT 735 75D ST5	-	X	-	-	-
MT 930 H	-	X	-	-	-
MT 930 HA	-	X	-	-	-
MT 933 Easy	-	X	-	-	-
MT 935 75D ST5	-	X	-	-	-
MT 1033 easy	-	X	-	-	-
MT 1135 75 D	-	X	-	-	-
MT 1135 H 100D	-	X	-	-	-
MT 1335 75D ST5	-	X	-	-	-
MT 1335 100D ST5	-	X	-	-	-
MT 1335 H 75D ST5	-	X	-	-	-
MT 1335 H 100D ST5	-	X	-	-	-
MT 1335 HA 75D ST5	-	X	-	-	-
MT 1335 HA 100D ST5	-	X	-	-	-
MT-X 733	-	X	-	-	-
MT-X 1033	-	X	-	-	-
MT 733 Easy	-	-	X	-	-
MT 933 Easy	-	-	X	-	-
MT 1033 easy	-	-	X	-	-
MT 1440 A ST5	-	-	-	X	X
MT 1440 easy ST5	-	-	-	X	X
MT 1440 HA ST5	-	-	-	X	X
MT 1440 ST5	-	-	-	X	X
MT 1840 A 100D ST5 S1	-	-	-	X	X
MT 1840 easy ST5	-	-	-	X	X
MT 1840 HA	-	-	-	X	X
MT 1840 ST5	-	-	-	X	X
MT-X 733	-	-	X	-	-
MT-X 1033	-	-	X	-	-
MT-X 1440	-	-	-	X	X
MT-X 1440 A	-	-	-	X	X
MT-X 1840	-	-	-	X	X
MT-X 1840 A	-	-	-	X	X

TFF 29 DL 1040

TFF 35 DL 1040

TFF 35 DL 1300

TFF 45 DL 1040

TFF 45 DL 1300

Machine compatibiliteit

MXT 840 K	-	-	-	X	-
MXT 840 P	-	-	-	X	-
MXT 1740 K	-	-	-	X	-
MXT 1740 P	-	-	-	X	-

VERPLICHTE UITRUSTING VAN MACHINES : 





NEW

VLOTTEND VORKENBORD MET SIDESHIFT (MRT)



- Opmerking: Verplichte verkeerskit in Italië. Neem contact op met uw dealer.
- Opmerking: de verkeersset is in Duitsland verplicht op MRTs Vision/Vision+. Neem contact op met uw dealer.

	TFF 1030 TDL 5 T	TFF 1030 TDL 5 T (b)
Capaciteit (kg)	5000	5000
Gewicht (kg)	532	625
Totale hoogte (mm)	1481	1481
Totale lengte (mm)	1662	1672
Breedte (mm)	1128	1128
Machine-apparatuur		
Zijverschuiving (mm)	100	100
Minimum spreiding vorken (mm)	360	410
Maximum spreiding vorken (mm)	1028	1028

Beschikbare vorkafmetingen

125 x 50 x 1200	924864	
150 x 60 x 1200		923956

Machine compatibiliteit

MRT 1645 75	X	X
MRT 1645 115	X	X
MRT 1845 75	X	X
MRT 1845 115	X	X
MRT 2145 115	X	X
MRT 2260	-	X
MRT 2260 e	-	X
MRT 2545 115	X	X
MRT 2570	-	X
MRT 2660	-	X
MRT 2660 e	-	X
MRT 3060	-	X
MRT 3570	-	X
MRT 3570 ES	-	X
MRT-X 1645	X	X
MRT-X 1845	X	X
MRT-X 2145	X	X
MRT-X 2260	-	X
MRT-X 2545	X	X
MRT-X 2570	-	X
MRT-X 2660	-	X
MRT-X 3060	-	X
MRT-X 3570	-	X
MRT-X 3570 ES	-	X

VERPLICHTE UITRUSTING VAN MACHINES : 



VORKVERSTELLER VOOR VLOTTENDE VORKEN



- Breedte van de vorken: 275/1010 mm.
- Verhoogde bescherming achteraan standaard.
- Nota : De afstand tussen de vorken wordt berekend vanuit het midden van de vorken.

- Een onmisbaar accessoire voor iedere bouwplaats.
 - en enkel model voor het volledige MT constructieverreikers gamma : positief voor verhuurvloten.
 - Combineer het voordeel van de zwevende vorken op oneffen terrein met het gemak van het hydraulisch verschuiven van de vorken.
 - Een zekere tijdswinst : de vorken uitschuiven vanuit de cabine.
 - De vorken hydraulisch verschuiven om aan te passen aan de verschillende soorten paletten.
- Veiligheid : vergrendeling van de vorken voor verplaatsingen op de weg.



	CAF 1260 / 4500 P
Capaciteit (kg)	4500
Gewicht (kg)	350
Totale hoogte (mm)	1184
Totale lengte (mm)	1532
Vorkgedeelte X Breedte vorken X Lengte vorken (mm)	50 X 100 X 1200
Breedte (mm)	1303
Machine-apparatuur	
Minimum spreiding vorken (mm)	384
Maximum spreiding vorken (mm)	1010

Beschikbare vorkafmetingen

120 x 50 x 1170	52000273
-----------------	----------

Machine compatibiliteit

MT 625 e	X
MT 625 HA	X
MT 730 H	X
MT 733 Easy	X
MT 735 75D ST5	X
MT 930 H	X
MT 930 HA	X
MT 933 Easy	X
MT 935 75D ST5	X
MT 1033 easy	X
MT 1135 75 D	X
MT 1135 H 100D	X
MT 1135 easy ST5	X
MT 1135 H easy ST5	X
MT 1135 HA Easy ST5	X
MT 1335 75D ST5	X
MT 1335 100D ST5	X
MT 1335	X
MT 1335 easy ST5	X
MT 1335 H 75D ST5	X
MT 1335 H 100D ST5	X
MT 1335 H easy ST5	X
MT 1335 HA 75D ST5	X
MT 1335 HA 100D ST5	X
MT 1335 HA easy ST5	X
MT 1440 A	X
MT 1440 HA	X
MT 1840 A	X
MT 1840 easy ST5	X
MT 1840 HA	X
MT-X 625 H	X
MT-X 733	X

CAF 1260 / 4500 P

Machine compatibiliteit

MT-X 1033	X
MT-X 1440	X
MT-X 1440 A	X
MT-X 1840	X
MT-X 1840 A	X

VERPLICHTE UITRUSTING VAN MACHINES : 



ZIJDELINGSE KANTELBARE VORKDEUR - LOAD BACKSPLASH (MLT - MT)



- Opschroefbare lastrugleuning voor een hogere laststabiliteit.
- Opmerking: te gebruiken met FEM-vorken.

	PFB 45N 1670 SS LB	PFB 25N 1020 SS LB	PFB 35N 1260 SS LB
Capaciteit (kg)	4500	2500	3500
Gewicht (kg)	595	170	210
Totale hoogte (mm)	1258	1222	1229
Breedte (mm)	1810	1044	1284
Machine-apparatuur	☐☐	☐☐	☐☐
Zijverschuiving (mm)	100	100	100

Beschikbare vorkafmetingen

125 x 45 x 1200		52000204	52000205
125 x 50 x 1200	52000206		

Machine compatibiliteit

ALT950	-	-	X
MLA-T 533-145 V+ - ST5	-	-	X
MLT-X 741 T LSU	X	-	-
MT 625 e	-	X	-
MT 625 HA	-	X	-
MT 733 Easy	-	-	X
MT 735 75D ST5	-	-	X
MT 933 Easy	-	-	X
MT 935 75D ST5	-	-	X
MT 1033 easy	-	-	X
MT 1135 75 D	-	-	X
MT 1135 H 100D	-	-	X
MT 1135 H easy ST5	-	-	X
MT 1135 HA Easy ST5	-	-	X
MT 1135 ST5	-	-	X
MT 1335 75D ST5	-	-	X
MT 1335 100D ST5	-	-	X
MT 1335	-	-	X
MT 1335 easy ST5	-	-	X
MT 1335 H 75D ST5	-	-	X
MT 1335 H 100D ST5	-	-	X
MT 1335 H easy ST5	-	-	X
MT 1335 HA 75D ST5	-	-	X
MT 1335 HA 100D ST5	-	-	X
MT 1335 ST5	-	-	X
MT 1440 A	X	-	-
MT 1440 A ST5	X	-	-
MT 1440 easy ST5	X	-	-
MT 1440 HA	X	-	-
MT 1440 HA ST5	X	-	-
MT 1440 ST5	X	-	-
MT 1840 A 100D ST5 S1	X	-	-
MT 1840 A	X	-	-
MT 1840 easy ST5	X	-	-

	PBF 45N 1670 SS LB	PFB 25N 1020 SS LB	PFB 35N 1260 SS LB
Machine compatibiliteit			
MT 1840 HA	X	-	-
MT 1840 HA	X	-	-
MT 1840 ST5	X	-	-
MT-X 733	-	-	X
MT-X 1033	-	-	X
MT-X 1440	X	-	-
MT-X 1440 A	X	-	-
MT-X 1840	X	-	-
MT-X 1840 A	X	-	-

VERPLICHTE UITRUSTING VAN MACHINES : 

GIEKEN

Bereik



- 124 Big bag handler
- 128 draaibare jib
- 130 Hijshaak voor zware lasten
- 132 Jib met 2 haken
- 135 Jib met 3 haken

- 137 Op frame gemonteerd haak
- 141 uitschuifbare jib
- 144 Uitschuifbare Jjib met lier
- 146 Verlengde Jib
- 149 Verlengde jib met lier



BIG BAG HANDLER



- Max. totale capaciteit van 4000 kg, 4 haken van elk 1000 kg.
- Stopvoorziening gelast bij elke haak, vermindert het risico van vallende zaken bij vergissing van de operator.
- Demper achteraan om het zwenken van de zakken tegen te gaan.
- Vergemakkelijkt het manipuleren van big bags op een veilige manier. De structuur met ronde buizen beschadigt de big bags niet en beperkt de kans op vallen. De verhoogde structuur laat toe om een trailer te laden zonder het dakzeil te beschadigen. Vervoert zowel big bags met 1, 2 of 4 lussen.



	HBB 1500 / 2400	HBB 2100 / 4000
Capaciteit (kg)	2400	4000
Gewicht (kg)	186	285
Totale hoogte (mm)	1322	1322
Totale lengte (mm)	1643	2181
Breedte over vorken (mm)	750	700
Breedte (mm)	1356	1356
Machine-apparatuur	×	×

Machine compatibiliteit		
Referentienummer	52781808	52691660
Referentievorkenbord schranklader	52578030	-
4 point Carriage	52742058	-
Euro Carriage	52742059	-
ALT950	X	-
GCT 3-14	X	-
GCT 3-14 +	X	-
MLA-T 533-145 V+ - ST5	X	-
MLT 420-60 H	X	-
MLT 625-75 H	X	-
MLT 630-115	X	-
MLT 630-115 V	X	-
MLT 630-115 V CP	X	-
MLT 635-130 PS+	X	-
MLT 635-140 V+	X	-
MLT 730-115 V	X	-
MLT 730-115 V CP	X	-
MLT 733-115	X	-
MLT 733-115 LSU	X	-
MLT 737-130 PS+	X	-
MLT 741-130 PS+	X	-
MLT 841-145 PS+	X	-
MLT 850-145 V+	X	X
MLT 940-140 V+	X	-
MLT 961-160 V+ L	X	X
MLT 1041-145 PS+L	X	-
MLT-X 625-75 H	X	-
MLT-X 732	X	-
MLT-X 735 T LSU	X	-
MLT-X 737-130 PS+	X	-
MLT-X 741-140 V+	X	-
MLT-X 741 T LSU	X	-
MLT-X 841 - 145 PS+	X	-
MLT-X 850-145 V+	X	X
MLT-X 961-160 V+ L	X	X
MLT-X 1035 LT LSU	X	-

	HBB 1500 / 2400	HBB 2100 / 4000
Machine compatibiliteit		
MLT-X 1041-145 PS+L	X	-
MRT 1645 75	X	-
MRT 1645 115	X	-
MRT 1845 75	X	-
MRT 1845 115	X	-
MRT 2145 115	X	-
MRT 2260	X	-
MRT 2260 e	X	-
MRT 2545 115	X	-
MRT 2570	X	-
MRT 2660	X	-
MRT 2660 e	X	-
MRT 3060	X	-
MRT 3570	X	-
MRT 3570 ES	X	-
MRT-X 1645	X	-
MRT-X 1845	X	-
MRT-X 2145	X	-
MRT-X 2260	X	-
MRT-X 2545	X	-
MRT-X 2570	X	-
MRT-X 2660	X	-
MRT-X 3060	X	-
MRT-X 3570	X	-
MRT-X 3570 ES	X	-
MT 420 H	X	-
MT 625 e	X	-
MT 625 HA	X	-
MT 733 Easy	X	-
MT 735 75D ST5	X	-
MT 933 Easy	X	-
MT 935 75D ST5	X	-
MT 1033 easy	X	-
MT 1135 75 D	X	-
MT 1135 H 100D	X	-
MT 1135 H easy ST5	X	-
MT 1135 ST5	X	-
MT 1335 75D ST5	X	-
MT 1335 100D ST5	X	-
MT 1335	X	-
MT 1335 H 75D ST5	X	-
MT 1335 H 100D ST5	X	-
MT 1335 HA 75D ST5	X	-
MT 1335 HA 100D ST5	X	-

	HBB 1500 / 2400	HBB 2100 / 4000
Machine compatibiliteit		
MT 1335 ST5	X	-
MT 1440 A	X	-
MT 1440 HA	X	-
MT 1840 A	X	-
MT 1840 HA	X	-
MT-X 625 H	X	-
MT-X 733	X	-
MT-X 1033	X	-
MT-X 1440	X	-
MT-X 1440 A	X	-
MT-X 1840	X	-
MT-X 1840 A	X	-
MXT 840 K	X	-
MXT 840 P	X	-
MXT 1740 K	X	-
MXT 1740 P	X	-
ULM 412 H	X	-
ULM 412 H	X	-
ULM 415 H	X	-
ULM 415 H	X	-

VERPLICHTE UITRUSTING VAN MACHINES : ✕





DRAAIBARE JIB



- Jib met één enkele haak en hydraulische rotatie 15°/15°.
- Hydraulische rotatie voor een hogere nauwkeurigheid.
- Eenvoudig en sterk werktuig.
- Gehomologeerde zelfsluitende draaiende haak.

- Максимальная защита при применении в туннельных работах.
- Для выполнения работ за пределами крыши (стандарта FOPS) нет необходимости вставать на раму платформы.
- На платформе можно использовать тяжелые инструменты.
- Бескомпромиссная безопасность: соответствует стандарту EN 280.

	PO 600 / 2500	PO 1000 / 1500	PO 2000 / 1000
Max. bereik (mm)	2500	1500	1000
Capaciteit (kg)	600	1000	2000
Gewicht (kg)	320	275	255
Totale hoogte (mm)	842	1056	842
Totale lengte (mm)	2874	1874	1374
Breedte (mm)	830	830	830
Machine-apparatuur			
Rotatie 1	15	15	15
Rotatie 2	15	15	15

Machine compatibiliteit			
Referentienummer	784641	784642	784643
MT 730 H	X	X	X
MT 733 Easy	X	X	X
MT 735 75D ST5	X	X	X
MT 930 H	X	X	X
MT 930 HA	X	X	X
MT 933 Easy	X	X	X
MT 935 75D ST5	X	X	X
MT 1033 easy	X	X	X
MT 1135 75 D	X	X	X
MT 1135 H 100D	X	X	X
MT 1335 75D ST5	X	X	X
MT 1335 100D ST5	X	X	X
MT 1335 H 75D ST5	X	X	X
MT 1335 H 100D ST5	X	X	X
MT 1335 HA 75D ST5	X	X	X
MT 1335 HA 100D ST5	X	X	X
MT 1440 A	X	X	X
MT 1440 easy ST5	X	-	-
MT 1440 HA	X	X	X
MT 1840 A	X	X	X
MT 1840 easy ST5	X	X	X
MT 1840 HA	X	X	X
MT-X 733	X	X	X
MT-X 1033	X	X	X
MT-X 1440	X	X	X
MT-X 1440 A	X	X	X
MT-X 1840	X	X	X
MT-X 1840 A	X	X	X

VERPLICHTE UITRUSTING VAN MACHINES : 



HIJSHAAK VOOR ZWARE LASTEN



- Hangende lastcapaciteit tot 12.000 kg.
- Veiligheid: gehomologeerde en zelfsluitende draaihaak.

- Doeltreffende en duurzame oplossing voor hangende lasten.
- Rechtstreeks bevestigd op de machine voor een veilige toepassing.
- Zeer compacte aankoppeling om de stabiliteit van de machine te behouden.

	JH 16000	JH 20000	PC 9 T	PC 25 T
Max. bereik (mm)	700	700	260	700
Capaciteit (kg)	16000	20000	9000	25000
Gewicht (kg)	340	355	129	460
Totale hoogte (mm)	1068	1208	960	1258
Totale lengte (mm)	943	943	425	985
Breedte (mm)	830	830	815	850
Machine-apparatuur	×	×	×	×

Machine compatibiliteit				
Referentienummer E-RECO	52702450	52702460	939970	53008289
MHT 10135 ST5	X	-	-	-
MHT 10160 ST5	X	-	-	-
MHT 10200 ST5	-	X	-	-
MHT 11250 ST5	-	-	-	X
MHT 12330	-	-	-	X
MHT-X 10135 ST3A	X	-	-	-
MHT-X 10160 ST3A	X	-	-	-
MHT-X 10200 ST3A	-	X	-	-
MHT-X 11250 ST3A	-	-	-	X
MHT-X 12330	-	-	-	X
MRT 2260	-	-	X	-
MRT 2260 e	-	-	X	-
MRT 2570	-	-	X	-
MRT 2660	-	-	X	-
MRT 2660 e	-	-	X	-
MRT 3060	-	-	X	-
MRT 3570	-	-	X	-
MRT 3570 ES	-	-	X	-
MRT-X 2260	-	-	X	-
MRT-X 2570	-	-	X	-
MRT-X 2660	-	-	X	-
MRT-X 3060	-	-	X	-
MRT-X 3570	-	-	X	-
MRT-X 3570 ES	-	-	X	-

VERPLICHTE UITRUSTING VAN MACHINES : ×



JIB MET 2 HAKEN



- 2 verschillende capaciteiten aangegeven op de jib in functie van het verstek.
- Veiligheid: de jib is uitgerust met gehomologeerde en zelfsluitende draaihaken.
- Robuuste en eenvoudige oplossing voor opgehangen lasten.
- Jib uitgerust met 2 haken past zich aan aan iedere bouwplaats



	P 4000	P 6000
Max. bereik (mm)	708	808
Capaciteit (kg)	4000	6000
Capaciteit 2 (kg)	1200	2000
Max bij reiken 2 (mm)	2708	2708
Gewicht (kg)	210	282
Totale lengte (mm)	2838	2838
Breedte (mm)	830	830
Machine-apparatuur	×	×

Machine compatibiliteit

Referentienummer	653226	-
MT 730 H	X	-
MT 733 Easy	X	-
MT 735 75D ST5	X	-
MT 930 H	X	-
MT 930 HA	X	-
MT 933 Easy	X	-
MT 935 75D ST5	X	-
MT 1033 easy	X	-
MT 1135 75 D	X	-
MT 1135 H 100D	X	-
MT 1135 easy ST5	X	-
MT 1135 H easy ST5	X	-
MT 1135 HA Easy ST5	X	-
MT 1335 75D ST5	X	-
MT 1335 100D ST5	X	-
MT 1335 H 75D ST5	X	-
MT 1335 H 100D ST5	X	-
MT 1335 HA 75D ST5	X	-
MT 1335 HA 100D ST5	X	-
MT 1440 A	X	-
MT 1440 HA	X	-
MT 1840 A	X	-
MT 1840 easy ST5	X	-
MT 1840 HA	X	-
MT-X 1440	X	-
MT-X 1440 A	X	-
MT-X 1840	X	-
MT-X 1840 A	X	-
MXT 840 K	X	-
MXT 840 P	X	-
MXT 1740 K	X	-
MXT 1740 P	X	-
Referentienummer E-RECO	921321	921322
MRT 1645 75	X	X

	P 4000	P 6000
Machine compatibiliteit		
MRT 1645 115	X	X
MRT 1845 75	X	X
MRT 1845 115	X	X
MRT 2145 115	X	X
MRT 2260	X	X
MRT 2260 e	X	X
MRT 2545 115	X	X
MRT 2570	X	X
MRT 2660	X	X
MRT 2660 e	X	X
MRT 3060	X	X
MRT 3570	X	X
MRT 3570 ES	X	X
MRT-X 1645	X	X
MRT-X 1845	X	X
MRT-X 2145	X	X
MRT-X 2260	X	X
MRT-X 2545	X	X
MRT-X 2570	X	X
MRT-X 2660	X	X
MRT-X 3060	X	X
MRT-X 3570	X	X
MRT-X 3570 ES	X	X

VERPLICHTE UITRUSTING VAN MACHINES : ✕



JIB MET 3 HAKEN



- 3 koppels verstek/capaciteit.
- Veiligheid: gehomologeerde zelfsluitende draaihaken.
- Versatile: 2 in 1 attachment.
- Handles rectangular and round bales as well as wrapped bales.
- Easy to use: from one attachment to another in less than 3 minutes.
- Handles up to 2 bales.
- Innovative: easy hitching system (no tools, no dismantling).

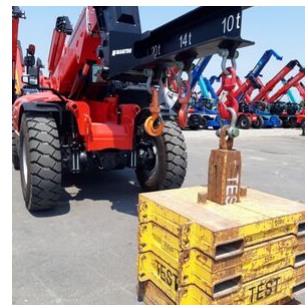

	JH 16 T - 10 T - 7.5 T	JH 20 T - 14 T - 10 T	JH 13.5 T - 10 T - 7.5 T	P 9 T	P 25 T	P 36 T
Max. bereik (mm)	700	700	700	470	700	905
Capaciteit (kg)	16000	20000	13500	9000	25000	36000
Capaciteit 2 (kg)	10000	14000	10000	5000	18000	16000
Capaciteit 3 (kg)	7500	10000	7500	2000	13000	10000
Max bij reiken 2 (mm)	1350	1350	1350	1385	1250	2005
Max bij reiken 3 (mm)	2000	2000	2000	2300	1800	3000
Gewicht (kg)	555	590	555	295	890	1490
Totale lengte (mm)	2215	2215	2215	2518	2085	3351
Breedte (mm)	830	830	830	815	850	1170
Machine-apparatuur	×	×	×	×	×	×

Machine compatibiliteit						
Referentienummer E-RECO	52701741	52701742	52701740	930830	53010431	52604320
MHT 790 ST5	-	-	-	X	-	-
MHT 10135 ST5	-	-	X	-	-	-
MHT 10160 ST5	X	-	-	-	-	-
MHT 10200 ST5	-	X	-	-	-	-
MHT 11250 ST5	-	-	-	-	X	-
MHT 12330	-	-	-	-	X	X
MHT-X 790 Mining	-	-	-	X	-	-
MHT-X 790 ST3A	-	-	-	X	-	-
MHT-X 10135 ST3A	-	-	X	-	-	-
MHT-X 10160 ST3A	X	-	-	-	-	-
MHT-X 10200 ST3A	-	X	-	-	-	-
MHT-X 11250 Mining	-	-	-	-	X	-
MHT-X 11250 ST3A	-	-	-	-	X	-
MHT-X 12330	-	-	-	-	X	X
MRT 2260 e	-	-	-	X	-	-
MRT 2570	-	-	-	X	-	-
MRT 2660 e	-	-	-	X	-	-
MRT 3570	-	-	-	X	-	-
MRT 3570 ES	-	-	-	X	-	-
MRT-X 2570	-	-	-	X	-	-
MRT-X 3570	-	-	-	X	-	-
MRT-X 3570 ES	-	-	-	X	-	-

VERPLICHTE UITRUSTING VAN MACHINES : ×



OP FRAME GEMONTEERD HAAK



- Breed gamma van 4000 kg tot 6000 kg.
- Rechstreekse aanbouw op de aankoppeling van de machine.
- Veiligheid: Gehomologeerde en zelfsluitende zwenkhaak.
- Eenvoudige en kostefficiënte oplossing om opgehangen lasten te verplaatsen

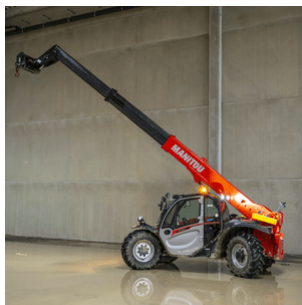

	JH 2500	PC 50	PC 60
Max. bereik (mm)	506	470	470
Capaciteit (kg)	2500	5000	6000
Gewicht (kg)	85	115	120
Totale hoogte (mm)	605	500	500
Totale lengte (mm)	654	606	606
Breedte (mm)	696	815	815
Machine-apparatuur	×	×	×

Machine compatibiliteit			
Referentienummer	-	708544	939050
All-Tach®	52579090	-	-
4 point Carriage	52742070	-	-
Euro Carriage	52742071	-	-
ALT950	-	X	-
GCT 3-14	X	-	-
GCT 3-14 +	X	-	-
MLA-T 533-145 V+ - ST5	-	X	-
MLT 420-60 H	-	X	-
MLT 625-75 H	-	X	-
MLT 841-145 PS+	-	X	-
MLT 850-145 V+	-	X	-
MLT 961-160 V+ L	-	-	X
MLT 1041-145 PS+L	-	X	-
MLT-X 625-75 H	-	X	-
MLT-X 741 T LSU	-	X	-
MLT-X 841 - 145 PS+	-	X	-
MLT-X 850-145 V+	-	X	-
MLT-X 961-160 V+ L	-	-	X
MLT-X 1041-145 PS+L	-	X	-
MT 420 H	-	X	-
MT 625 e	-	X	-
MT 625 HA	-	X	-
MT 733 Easy	-	X	-
MT 735 75D ST5	-	X	-
MT 933 Easy	-	X	-
MT 935 75D ST5	-	X	-
MT 1033 easy	-	X	-
MT 1135 75 D	-	X	-
MT 1135 H 100D	-	X	-
MT 1135 ST5	-	X	-
MT 1335 75D ST5	-	X	-
MT 1335 100D ST5	-	X	-
MT 1335	-	X	-
MT 1335 H 75D ST5	-	X	-
MT 1335 H 100D ST5	-	X	-

	JH 2500	PC 50	PC 60
Machine compatibiliteit			
MT 1335 HA 75D ST5	-	X	-
MT 1335 HA 100D ST5	-	X	-
MT 1335 ST5	-	X	-
MT 1440 A	-	X	-
MT 1440 HA	-	X	-
MT 1840 A	-	X	-
MT 1840 HA	-	X	-
MT-X 625 H	-	X	-
MT-X 733	-	X	-
MT-X 733 Mining	-	X	-
MT-X 1033	-	X	-
MT-X 1033 Mining	-	X	-
MT-X 1033 A Mining	-	X	-
MT-X 1440	-	X	-
MT-X 1440 A	-	X	-
MT-X 1840	-	X	-
MT-X 1840 A	-	X	-
ULM 412 H	X	-	-
ULM 412 H	X	-	-
ULM 415 H	X	-	-
ULM 415 H	X	-	-
Referentienummer E-RECO	-	921335	939050
MRT 1645 75	-	X	X
MRT 1645 115	-	X	X
MRT 1845 75	-	X	X
MRT 1845 115	-	X	X
MRT 2145 115	-	X	X
MRT 2260	-	X	X
MRT 2260 e	-	X	X
MRT 2545 115	-	X	X
MRT 2570	-	X	X
MRT 2660	-	X	X
MRT 2660 e	-	X	X
MRT 3060	-	X	X
MRT 3570	-	X	X
MRT 3570 ES	-	X	X
MRT-X 1645	-	X	X
MRT-X 1845	-	X	X
MRT-X 2145	-	X	X
MRT-X 2260	-	X	X
MRT-X 2545	-	X	X
MRT-X 2570	-	X	X
MRT-X 2660	-	X	X
MRT-X 3060	-	X	X

JH 2500	PC 50	PC 60
---------	-------	-------

Machine compatibiliteit			
MRT-X 3570	-	X	X
MRT-X 3570 ES	-	X	X

VERPLICHTE UITRUSTING VAN MACHINES : ✕



UITSCHUIFBARE JIB



- Capaciteit 600 kg @ 4 m/300 kg @ 5 m/100 kg @ 6 m.
- Veiligheid: speciaal gehomologeerde zelfsluitende draaihaak.
- Veiligheid: gehomologeerde en zelfsluitende standaard draaihaak.
- Eenvoudige en veilige manuele verlenging.
- Geïntegreerde steunvoet voor een eenvoudige stockage.

- Accessoire simple et efficace.
- Permet une pénétration précise et propre dans la matière grâce à ses dents arrondies.
- Manipulation de 2 balles rondes et 3 balles rectangulaires.
- Option : Porte dents baïonnettes garantissant une excellente stabilité lors de la manutention de balles rectangulaires.

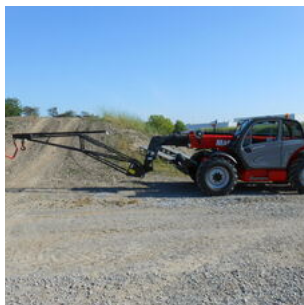

	JE 6000 / 600
Max. bereik (mm)	3895
Capaciteit (kg)	600
Capaciteit 2 (kg)	300
Capaciteit 3 (kg)	100
Max bij reiken 2 (mm)	4845
Max bij reiken 3 (mm)	5845
Gewicht (kg)	265
Totale lengte (mm)	4347
Breedte (mm)	815
Machine-apparatuur	×

Machine compatibiliteit	
Referentienummer	939995
MRT 2260	X
MRT 2260 e	X
MRT 2570	X
MRT 2660	X
MRT 2660 e	X
MRT 3060	X
MRT 3570	X
MRT 3570 ES	X
MRT-X 2260	X
MRT-X 2570	X
MRT-X 2660	X
MRT-X 3060	X
MRT-X 3570	X
MRT-X 3570 ES	X
MT 730 H	X
MT 733 Easy	X
MT 735 75D ST5	X
MT 930 H	X
MT 930 HA	X
MT 933 Easy	X
MT 935 75D ST5	X
MT 1033 easy	X
MT 1135 75 D	X
MT 1135 H 100D	X
MT 1135 H easy ST5	X
MT 1335 75D ST5	X
MT 1335 100D ST5	X
MT 1335	X
MT 1335 H 75D ST5	X
MT 1335 H 100D ST5	X
MT 1335 HA 75D ST5	X
MT 1335 HA 100D ST5	X
MT 1440 A	X

JE 6000 / 600

Machine compatibiliteit

MT 1440 HA	X
MT 1840 A	X
MT 1840 HA	X
MT-X 1440	X
MT-X 1440 A	X
MT-X 1840	X
MT-X 1840 A	X





VERPLICHTE UITRUSTING VAN MACHINES : ✕



UITSCHUIFBARE JJIB MET LIER



- Negatieve rem in oliebad.
- Veiligheid: gehomologeerde en zelfsluitende draaihaak.
- Veiligheid: einde kabel/haak in bovenste positie, automatische stop van de beweging.
- Manuele verlenging (manuele lier) met regelbare giek lengte.
- Oplossing om hangende lasten te verhandelen op alle soorten werven.
- Perfect om gebinten, kaders en andere lichte en grote elementen te vervoeren en te plaatsen.
- De telescopische giek biedt een grotere flexibiliteit alsook een groter bereik vooraan.
- Buizenstructuur ontworpen voor een optimaal gewicht/stijfheid verhouding
- Uitstekende aanpassingsmogelijkheden.

	JWE 7000 / 800 39M	PT 800
Max. bereik (mm)	4525	4525
Werkhoogte (mm)	41000	32000
Capaciteit (kg)	800	800
Capaciteit 2 (kg)	1000	1000
Max bij reiken 2 (mm)	7183	7183
Gewicht (kg)	605	605
Totale lengte (mm)	4632	4632
Breedte (mm)	870	870
Lengte kabel (mm)	49000	37000
Machine-apparatuur	 + 	 + 
Hoeksnelheid (m/mn)	30	30

Machine compatibiliteit		
Referentienummer E-RECO	52717860	921323
MRT 1845 75	X	-
MRT 1845 115	X	-
MRT 2145 115	X	-
MRT 2260	X	X
MRT 2260 e	X	-
MRT 2545 115	X	-
MRT 2570	X	X
MRT 2660	X	X
MRT 2660 e	X	-
MRT 3060	X	X
MRT 3570	X	X
MRT 3570 ES	X	X
MRT-X 1845	X	-
MRT-X 2145	X	-
MRT-X 2260	X	X
MRT-X 2545	X	-
MRT-X 2570	X	X
MRT-X 2660	X	X
MRT-X 3060	X	X
MRT-X 3570	X	X
MRT-X 3570 ES	X	X

VERPLICHTE UITRUSTING VAN MACHINES :  + 



VERLENGDE JIB



- Breed gamma jib's van 600 kg tot 2000 kg met een max. verstek van 2,5 m tot 4 m.
- Veiligheid: gehomologeerde en zelfsluitende draaihaak.
- Verlengde jib ook beschikbaar in lier-uitvoering.
- Eenvoudige en lichte oplossing om opgehangen lasten te verplaatsen.
- Ideaal voor het plaatsen en verplaatsen van balken, gebintes en andere lichte en omvangrijke lasten.
- Het ontwerp zorgt ervoor dat u bij moeilijk bereikbare plaatsen komt en de reikwijdte van uw verreiker wordt vergroot.
- Buizenstructuur voor een ideale verhouding tussen het gewicht en de stijfheid.



	P 600	P 1000	P 1500	P 2000
Max. bereik (mm)	3746	3797	2677	2336
Capaciteit (kg)	600	1000	1500	2000
Gewicht (kg)	210	210	165	190
Totale hoogte (mm)	990	1547	1250	802
Totale lengte (mm)	3947	4120	2956	2479
Breedte (mm)	830	815	815	815
Machine-apparatuur	×	×	×	×

Machine compatibiliteit

Referentienummer	653228	-	-	-
MT 730 H	X	-	-	-
MT 733 Easy	X	-	-	-
MT 735 75D ST5	X	-	-	-
MT 930 H	X	-	-	-
MT 930 HA	X	-	-	-
MT 933 Easy	X	-	-	-
MT 935 75D ST5	X	-	-	-
MT 1033 easy	X	-	-	-
MT 1135 75 D	X	-	-	-
MT 1135 H 100D	X	-	-	-
MT 1135 easy ST5	X	-	-	-
MT 1135 H easy ST5	X	-	-	-
MT 1135 HA Easy ST5	X	-	-	-
MT 1335 75D ST5	X	-	-	-
MT 1335 100D ST5	X	-	-	-
MT 1335 easy ST5	X	-	-	-
MT 1335 H 75D ST5	X	-	-	-
MT 1335 H 100D ST5	X	-	-	-
MT 1335 H easy ST5	X	-	-	-
MT 1335 HA 75D ST5	X	-	-	-
MT 1335 HA 100D ST5	X	-	-	-
MT 1335 HA easy ST5	X	-	-	-
MT 1440 A	X	-	-	-
MT 1440 easy ST5	X	-	-	-
MT 1440 HA	X	-	-	-
MT 1840 A	X	-	-	-
MT 1840 easy ST5	X	-	-	-
MT 1840 HA	X	-	-	-
MT-X 733	X	-	-	-
MT-X 733 Mining	X	-	-	-
MT-X 1033	X	-	-	-
MT-X 1033 Mining	X	-	-	-
MT-X 1440	X	-	-	-
MT-X 1440 A	X	-	-	-
MT-X 1840	X	-	-	-

P 600	P 1000	P 1500	P 2000
-------	--------	--------	--------

Machine compatibiliteit				
MT-X 1840 A	X	-	-	-
MXT 840 K	X	-	-	-
MXT 840 P	X	-	-	-
MXT 1740 K	X	-	-	-
MXT 1740 P	X	-	-	-
TX 408	X	-	-	-
TX 4017	X	-	-	-
Referentienummer E-RECO	921316	921317	921319	921320
MRT 1645 75	X	X	X	X
MRT 1645 115	X	X	X	X
MRT 1845 75	X	X	X	X
MRT 1845 115	X	X	X	X
MRT 2145 115	X	X	X	X
MRT 2260	X	X	X	X
MRT 2260 e	X	X	X	X
MRT 2545 115	X	X	X	X
MRT 2570	X	X	X	X
MRT 2660	X	X	X	X
MRT 2660 e	X	X	X	X
MRT 3060	X	X	X	X
MRT 3570	X	X	X	X
MRT 3570 ES	X	X	X	X
MRT-X 1645	X	X	X	X
MRT-X 1845	X	X	X	X
MRT-X 2145	X	X	X	X
MRT-X 2260	X	X	X	X
MRT-X 2545	X	X	X	X
MRT-X 2570	X	X	X	X
MRT-X 2660	X	X	X	X
MRT-X 3060	X	X	X	X
MRT-X 3570	X	X	X	X
MRT-X 3570 ES	X	X	X	X

VERPLICHTE UITRUSTING VAN MACHINES : ✕









VERLENGDE JIB MET LIER



- Breed gamma Jib's met lier van 600 kg tot 2000 kg met een max. verstek van 4 m.
- Negatieve rem in oliebad.
- Veiligheid: gehomologeerde en zelfsluitende draaihaak.
- Eindsensor (heffen en zakken).
- Oplossing om hangende lasten te verhandelen op een werf.
- Tovert je verreiker un een mobiele kraan.
- Ideaal om spanten, geraamte en andere hangende lasten te vervoeren en te plaatsen.
- Combinatie van het verstekeffect van een Jib met de veelzijdigheid van een lier.
- Buizenstructuur ontworpen voor een optimaal gewicht/stijfheid ratio.







	JW 1950 LB	JW 2500 / 2000 22M	JW 2500 / 2000 35M	JW 3000 / 1500 44M	JW 4100 / 600 68M	JW 4100 / 1000 34M
Max. bereik (mm)	3542	2008	2008	2633	3703	3542
Werkhoogte (mm)	27000	24000	24000	35000	38000	27000
Capaciteit (kg)	1950	2000	2000	1500	600	1000
Gewicht (kg)	382	389	400	368	94	299
Totale lengte (mm)	4107	2516	2516	2990	4107	4107
Kabellus	1	1	1	Direct	Direct	1
Breedte (mm)	810	815	815	815	810	810
Lengte kabel (mm)	56000	49000	70000	37000	40000	56000
Machine-apparatuur						
Hoeksnelheid (m/mn)	44	24	24	35	94	44

Machine compatibiliteit

Referentienummer E-RECO	52718275	52718250	52717582	52717710	52719496	52719497
MRT 1645 75	-	X	X	X	X	X
MRT 1645 115	-	X	X	X	X	X
MRT 1845 75	-	X	X	X	X	X
MRT 1845 115	-	X	X	X	X	X
MRT 2145 115	-	X	X	X	X	X
MRT 2260	X	X	X	X	X	X
MRT 2260 e	X	X	-	X	X	X
MRT 2545 115	-	X	X	X	X	X
MRT 2570	X	X	X	X	X	X
MRT 2660	X	X	X	X	X	X
MRT 2660 e	X	-	X	X	X	X
MRT 3060	X	X	X	X	X	X
MRT 3570	X	X	X	X	X	X
MRT 3570 ES	X	X	X	X	X	X
MRT-X 1645	-	X	X	X	X	X
MRT-X 1845	-	X	X	X	X	X
MRT-X 2145	-	X	X	X	X	X
MRT-X 2260	X	X	X	X	X	X
MRT-X 2545	-	X	X	X	X	X
MRT-X 2570	X	X	X	X	X	X
MRT-X 2660	X	X	X	X	X	X
MRT-X 3060	X	X	X	X	X	X
MRT-X 3570	X	X	X	X	X	X
MRT-X 3570 ES	X	X	X	X	X	X

VERPLICHTE UITRUSTING VAN MACHINES : 

	PT 600	PT 1000	PT 1500	PT 2000 (a)	PT 2000 (b)
Max. bereik (mm)	4104	4104	2633	2008	2008
Werkhoogte (mm)	38000	27000	35000	24000	24000
Capaciteit (kg)	600	1000	1500	2000	2000
Gewicht (kg)	278	299	370	389	400
Totale lengte (mm)	4104	3949	2887	2388	2387
Kabellus	Direct	1	Direct	1	1
Breedte (mm)	815	815	815	815	815
Lengte kabel (mm)	40000	56000	37000	49000	70000
Machine-apparatuur					
Hoeksnelheid (m/mn)	94	44	48	24	24

Machine compatibiliteit					
Referentienummer E-RECO	921325	921326	921330	921331	939392
MRT 1645 75	X	X	X	X	X
MRT 1645 115	X	X	X	X	X
MRT 1845 75	X	X	X	X	X
MRT 1845 115	X	X	X	X	X
MRT 2145 115	X	X	X	X	X
MRT 2260	X	X	X	X	X
MRT 2545 115	X	X	X	X	X
MRT 2570	X	X	X	X	X
MRT 2660	X	X	X	X	X
MRT 3060	X	X	X	X	X
MRT 3570	X	X	X	X	X
MRT 3570 ES	X	X	X	X	X
MRT-X 1645	X	X	X	X	X
MRT-X 1845	X	X	X	X	X
MRT-X 2145	X	X	X	X	X
MRT-X 2260	X	X	X	X	X
MRT-X 2545	X	X	X	X	X
MRT-X 2570	X	X	X	X	X
MRT-X 2660	X	X	X	X	X
MRT-X 3060	X	X	X	X	X
MRT-X 3570	X	X	X	X	X
MRT-X 3570 ES	X	X	X	X	X

VERPLICHTE UITRUSTING VAN MACHINES :  + 

PLATFORMEN

Bereik

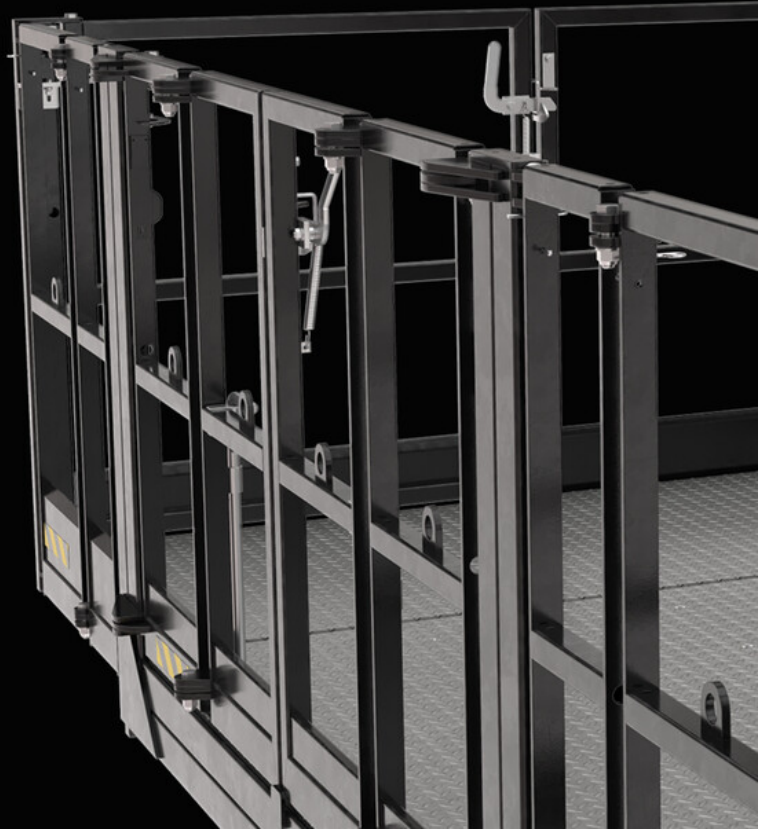

- 154 3D roterend pendelend platform
- 157 Aerial Jib 1
- 159 Aerial Jib 2
- 161 Aluminium werkkooi
- 163 Dakdekkers platform
- 166 Diep uitbreidbaar platform
- 168 Platform

- 172 Snel openende platform
- 177 Uitbreidbaar platform
- 180 Vast zwenkbare dakwerkerskooi
- 182 Verhoogd uitbreidbaar platform
- 184 Werkkooi met afneembaar FOPS dak
- 186 werkkooi met lier



3D ROTEREND PENDELEND PLATFORM



- Telescopische verticale mast + negatief.
- Rotatie van de giek van 170° aan beide kanten van de werkkooi.
- Positieve en negatieve werkzone voor de toepassingen.
- Gehomologeerd voor 2 personen.
- Giekpositiesensor.
- Aanwezigheidssensor in de vergrendelpin.
- Maximale veiligheid voor personen.
- Een pendulair ontwerp en structuur om onder een brug te kunnen werken.
- Metalen antislip vloer.



	P 3D 1000 / 200 L6700	P 3D 1000 / 200 L7500
Aantal personen	2	2
Capaciteit met personen inbegrepen (kg)	200	200
Gewicht (kg)	1030	1030
Totale hoogte (mm)	2900	2900
Totale lengte (mm)	7647	8390
Breedte (mm)	1676	1676
Diepte (mm)	680	620
Working reach max. (mm)	8170	8540
Machine-apparatuur		
Working height positive (mm)	9560	11100
Working width - angled (mm)	1100	1100
Werkbereik (mm)	6700	7500
Rotatie 1	170	170
Rotatie 2	170	170

Machine compatibiliteit		
Referentienummer E-RECO	52719363	52719270
MRT 1645 75	-	X
MRT 1645 115	-	X
MRT 1845 75	X	-
MRT 1845 115	X	-
MRT 2145 115	-	X
MRT 2260	-	X
MRT 2260 e	-	X
MRT 2545 115	-	X
MRT 2570	-	X
MRT 2660	-	X
MRT 2660 e	-	X
MRT 3060	-	X
MRT 3570	-	X
MRT 3570 ES	-	X
MRT-X 1645	-	X
MRT-X 1845	X	-
MRT-X 2145	-	X
MRT-X 2260	-	X
MRT-X 2545	-	X
MRT-X 2570	-	X
MRT-X 2660	-	X
MRT-X 3060	-	X
MRT-X 3570	-	X
MRT-X 3570 ES	-	X
Referentienummer E-RECO 2	52719674	52719672
MRT 1645 75	-	X
MRT 1645 115	-	X
MRT 1845 75	X	-

P 3D 1000 / 200 L6700

P 3D 1000 / 200 L7500

Machine compatibiliteit		
MRT 1845 115	X	-
MRT 2145 115	-	X
MRT 2260	-	X
MRT 2260 e	-	X
MRT 2545 115	-	X
MRT 2570	-	X
MRT 2660	-	X
MRT 2660 e	-	X
MRT 3060	-	X
MRT 3570	-	X
MRT 3570 ES	-	X
MRT-X 1645	-	X
MRT-X 1845	X	-
MRT-X 2145	-	X
MRT-X 2260	-	X
MRT-X 2545	-	X
MRT-X 2570	-	X
MRT-X 2660	-	X
MRT-X 3060	-	X
MRT-X 3570	-	X
MRT-X 3570 ES	-	X

VERPLICHTE UITRUSTING VAN MACHINES :  +  + 



AERIAL JIB 1



- Rotatie van 90° aan beide kanten van de werkkooi.
- Breedte van de werkkooi : 2690 mm.
- Gehomologeerd & nbsp; voor 2 personen.
- Telescopische giek (1630 mm).
- Maximale veiligheid voor het heffen van personen.
- Positieve werkzone voor verschillende toepassingen.
- Brede werkkooi met grote capaciteit.

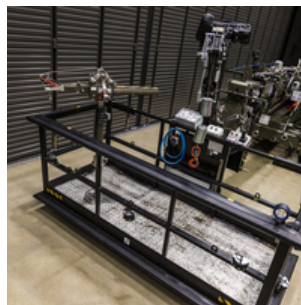

PAJ1 2500 / 300	
Aantal personen	3
Capaciteit met personen inbegrepen (kg)	300
Gewicht (kg)	930
Totale hoogte (mm)	1995
Totale lengte (mm)	4432
Breedte (mm)	2690
Machine-apparatuur	
Rotatie 1	90
Rotatie 2	90

Machine compatibiliteit	
Referentienummer E-RECO	52719268
MRT 1645 75	X
MRT 1645 115	X
MRT 1845 75	X
MRT 1845 115	X
MRT 2145 115	X
MRT 2260	X
MRT 2260 e	X
MRT 2545 115	X
MRT 2570	X
MRT 2660	X
MRT 2660 e	X
MRT 3060	X
MRT 3570	X
MRT 3570 ES	X
MRT-X 1645	X
MRT-X 1845	X
MRT-X 2145	X
MRT-X 2260	X
MRT-X 2545	X
MRT-X 2570	X
MRT-X 2660	X
MRT-X 3060	X
MRT-X 3570	X
MRT-X 3570 ES	X

VERPLICHTE UITRUSTING VAN MACHINES : 



AERIAL JIB 2



- 344° totale rotatie van de giek van het werktuig.
- Breedte van de werkkooi: 1200 mm x diepte 800 mm.
- Gehomologeerd voor 2 personen.
- Brede steunpoot voor een maximale stabiliteit bij een positieverandering positief/negatief.
- Telescopische giek (2300 mm).
- Maximale veiligheid voor personen.
- Positieve werkzone (+9,3m).
- Negatieve werkzone (-6,4m)
- Reikwijdte van de werkzone vooraan (+6,81 m)

PAJ2 1200 / 200	
Aantal personen	2
Capaciteit met personen inbegrepen (kg)	200
Gewicht (kg)	1200
Totale hoogte (mm)	2823
Totale lengte (mm)	4471
Breedte (mm)	1200
Diepte (mm)	800
Machine-apparatuur	
Rotatie 1	172
Rotatie 2	172

Machine compatibiliteit	
Referentienummer E-RECO	52719269
MRT 1645 75	X
MRT 1645 115	X
MRT 1845 75	X
MRT 1845 115	X
MRT 2145 115	X
MRT 2260	X
MRT 2260 e	X
MRT 2545 115	X
MRT 2570	X
MRT 2660	X
MRT 2660 e	X
MRT 3060	X
MRT 3570	X
MRT 3570 ES	X
MRT-X 1645	X
MRT-X 1845	X
MRT-X 2145	X
MRT-X 2260	X
MRT-X 2545	X
MRT-X 2570	X
MRT-X 2660	X
MRT-X 3060	X
MRT-X 3570	X
MRT-X 3570 ES	X

VERPLICHTE UITRUSTING VAN MACHINES : 





ALLUMINIUM WERKKOOI

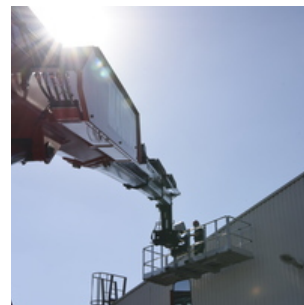
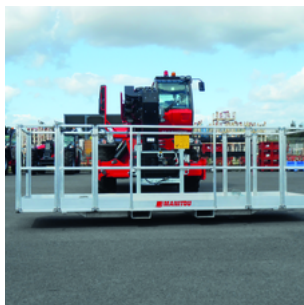

- Werkkooi 100 % aluminium (rotatie : staal).
- Conform aan de EN 280 veiligheidsnorm: railing voor de passagiers, bevestigingspunten voor de harnessen, enz.
- 3 ingangen met schuifstaven (1 vooraan, 1 links, 1 rechts).
- Eenvoudig aan en af te bouwen, kan enkel van één kant opengeklapt worden.
- + 1 m bereik vooraan ten opzichte van de stalen uitvoering (PSE 4400/365).
- 150 kg lichter dan staal.
- Doeltreffender werken, meer doen vanuit één enkele positie van de machine.
- Een veiligheid zonder compromissen.
- Eenvoudig toegankelijk vanuit beide kanten van de werkkooi, zelfs als deze dichtgeplooid is.
- Een perfecte aanpassing aan de werksomstandigheden.



PSE 4200 / 365 ALU	
Aantal personen	3
Capaciteit met personen inbegrepen (kg)	365
Gewicht (kg)	500
Totale hoogte (mm)	1252
Totale lengte (mm)	2311
Minimale breedte (mm)	2340
Maximale breedte (mm)	4150
Diepte (mm)	1260
Machine-apparatuur	 + 
Rotatie 1	90
Rotatie 2	90

Machine compatibiliteit	
Referentienummer E-RECO	939445
MRT 2260	X
MRT 2570	X
MRT 2660	X
MRT 3060	X
MRT 3570	X
MRT 3570 ES	X
MRT-X 2260	X
MRT-X 2570	X
MRT-X 2660	X
MRT-X 3060	X
MRT-X 3570	X
MRT-X 3570 ES	X
Referentienummer E-RECO 2	52719247
MRT 2260	X
MRT 2260 e	X
MRT 2570	X
MRT 2660	X
MRT 2660 e	X
MRT 3060	X
MRT 3570	X
MRT 3570 ES	X
MRT-X 2260	X
MRT-X 2570	X
MRT-X 2660	X
MRT-X 3060	X
MRT-X 3570	X
MRT-X 3570 ES	X

VERPLICHTE UITRUSTING VAN MACHINES :  + 











DAKDEKKERS PLATFORM



- Capaciteit 1000 kg.
- Draaibare werkkooi +/- 90° van beide kanten.
- Wettelijk toegestaan voor 3 personen.
- Bewegingsensor dat alle bewegingen verbiedt na de opening van de deuren.
- Overbelastingssensor.
- Fysieke sensor waardoor de opening enkel mogelijk is bij een contact met het dak.

VFeX3zAAADcA6215



	NC 365	NC 1000	PSR 2400 / 365 3P	PSR 2400 / 1000 3P
Aantal personen	3	3	3	3
Capaciteit met personen inbegrepen (kg)	365	1000	365	1000
Gewicht (kg)	1310	1210	1315	1215
Totale hoogte (mm)	1614	1614	1954	1954
Totale lengte (mm)	2920	2605	2920	2605
Minimale breedte (mm)	2420	2420	2420	2420
Maximale breedte (mm)	3682	3682	3682	3682
Diepte (mm)	1260	1218	1260	1218
Machine-apparatuur	 + 	 + 	 + 	 + 
Rotatie 1	90	90	90	90
Rotatie 2	90	90	90	90

Machine compatibiliteit

Referentienummer	788789	788791	-	-
MT 1335 HA 75D ST5	X	-	-	-
MT 1335 HA 100D ST5	X	-	-	-
MT 1440 A	X	X	-	-
MT 1440 HA	X	X	-	-
MT 1840 A	X	X	-	-
MT 1840 HA	X	X	-	-
MT-X 1440 A	X	X	-	-
MT-X 1840 A	X	X	-	-
Referentienummer E-RECO	923309	921294	52719259	52719260
MRT 1645 75	X	X	X	X
MRT 1645 115	X	X	X	X
MRT 1845 75	X	X	X	X
MRT 1845 115	X	X	X	X
MRT 2145 115	X	X	X	X
MRT 2260	X	X	X	X
MRT 2260 e	-	-	X	X
MRT 2545 115	X	X	X	X
MRT 2570	X	X	X	X
MRT 2660	X	X	X	X
MRT 2660 e	-	-	X	X
MRT 3060	X	X	X	X
MRT 3570	X	X	X	X
MRT 3570 ES	X	X	X	X
MRT-X 1645	X	X	X	X
MRT-X 1845	X	X	X	X
MRT-X 2145	X	X	X	X
MRT-X 2260	X	X	X	X
MRT-X 2545	X	X	X	X
MRT-X 2570	X	X	X	X
MRT-X 2660	X	X	X	X
MRT-X 3060	X	X	X	X

NC 365

NC 1000

PSR 2400 / 365 3P

PSR 2400 / 1000 3P

Machine compatibiliteit

MRT-X 3570	X	X	X	X
MRT-X 3570 ES	X	X	X	X

VERPLICHTE UITRUSTING VAN MACHINES :  + 







DIEP UITBREIDBAAR PLATFORM



- 2m deep platform to facilitate the handling of bulky loads in the platform.
- Interesting for asbestos removal and 2nd fix applications- easy access & significant space to place tiles.



	NAC 2 2.5 / 4m 1000kg	ORH 2 2.5 / 4m 700kg	PFE 4000 / 1000 FD	PSE 4000 / 700 FD
Aantal personen	3	3	3	3
Capaciteit met personen inbegrepen (kg)	1000	700	1000	700
Gewicht (kg)	1000	1300	1000	1300
Totale hoogte (mm)	1290	1290	1669	1669
Totale lengte (mm)	2615	2855	2615	2855
Minimale breedte (mm)	2500	2500	2500	2500
Maximale breedte (mm)	4046	4046	4000	4046
Diepte (mm)	1920	1920	1920	1920
Machine-apparatuur				
Werkbereik (mm)	2000	2000	2000	2000
Rotatie 1	-	40	-	40
Rotatie 2	-	40	-	40

Machine compatibiliteit

Referentienummer E-RECO	921355	921358	52719265	52719266
MRT 1645 75	X	X	X	X
MRT 1645 115	X	X	X	X
MRT 1845 75	X	X	X	X
MRT 1845 115	X	X	X	X
MRT 2145 115	X	X	X	X
MRT 2260	X	X	X	X
MRT 2260 e	-	-	X	X
MRT 2545 115	X	X	X	X
MRT 2570	X	X	X	X
MRT 2660	X	X	X	X
MRT 2660 e	-	-	X	X
MRT 3060	X	X	X	X
MRT 3570	X	X	X	X
MRT 3570 ES	X	X	X	X
MRT-X 1645	X	X	X	X
MRT-X 1845	X	X	X	X
MRT-X 2145	X	X	X	X
MRT-X 2260	X	X	X	X
MRT-X 2545	X	X	X	X
MRT-X 2570	X	X	X	X
MRT-X 2660	X	X	X	X
MRT-X 3060	X	X	X	X
MRT-X 3570	X	X	X	X
MRT-X 3570 ES	X	X	X	X







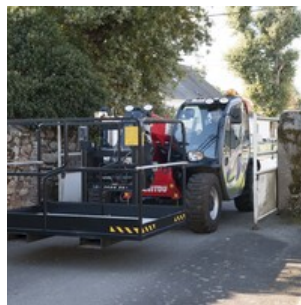

PLATFORM



- Capaciteit 200 of 365 kg
- Vaste of draaiende 90°/90° uitvoering
- Gehomologeerd voor 2 personen (200 kg) of 3 personen (365 kg), de capaciteit in kg omvat de personen
- Slotsensor en overcapaciteitsensor (365 kg)
- Antislip bodem
- Absolute veiligheid voor het heffen van personen.
- Eenvoudige en efficiënte werkkooi.
- Kosten efficiënte oplossing om personen te heffen.
- Veiligheid : leuning rondom de werkkooi, zijdelingse toegang.
- Vorksleuven om de kooi te verplaatsen of te laden op een vrachtwagen.



	NAC 2M	NAC 1.2 x 0.8 M	ORH	PF 1200 / 200 2P	PF 2000 / 365 3P	PF 2000 / 365	PS 2000 / 365 3P
Aantal personen	3	2	3	2	3	3	3
Capaciteit met personen inbegrepen (kg)	365	200	365	200	365	365	365
Gewicht (kg)	404	165	570	165	393	409	570
Totale hoogte (mm)	1292	1240	1292	1240	1631	1631	1319
Totale lengte (mm)	1812	1095	2490	1173	1812	1755	2490
Breedte (mm)	2190	1391	2130	1391	2190	2190	2190
Diepte (mm)	1150	740	1150	740	1150	1150	1150
Machine-apparatuur							
Rotatie 1	-	-	90	-	-	-	90
Rotatie 2	-	-	90	-	-	-	90

Machine compatibiliteit

Referentienummer	788782	939382	-	-	-	-	-
MT 625 HA	X	X	-	-	-	-	-
MT 930 HA	X	X	-	-	-	-	-
MT 1135 HA Easy ST5	X	-	-	-	-	-	-
MT 1335 100D ST5	X	-	-	-	-	-	-
MT 1335 HA 100D ST5	X	-	-	-	-	-	-
MT 1335 HA easy ST5	X	-	-	-	-	-	-
MT 1440 A	X	-	-	-	-	-	-
MT 1440 HA	X	-	-	-	-	-	-
MT 1840 A	X	-	-	-	-	-	-
MT 1840 HA	X	-	-	-	-	-	-
MT-X 1440 A	X	-	-	-	-	-	-
MT-X 1840 A	X	-	-	-	-	-	-
Referentienummer E-RECO	921296	923345	921304	52719244	52719245	52727780	52719246
MHT 790 ST5	-	-	-	-	X	-	-
MHT 10135 ST5	-	-	-	-	-	X	-
MHT 10160 ST5	-	-	-	-	-	X	-
MHT 10200 ST5	-	-	-	-	-	X	-
MHT 11250 ST5	-	-	-	-	-	X	-
MHT-X 790 ST3A	-	-	-	-	X	-	-
MHT-X 10135 ST3A	-	-	-	-	-	X	-
MHT-X 10160 ST3A	-	-	-	-	-	X	-
MHT-X 10200 ST3A	-	-	-	-	-	X	-
MHT-X 11250 ST3A	-	-	-	-	-	X	-
MRT 1645 75	-	-	X	-	X	-	X
MRT 1645 115	-	-	X	-	X	-	X
MRT 1845 75	-	-	X	-	X	-	X
MRT 1845 115	-	-	X	-	X	-	X
MRT 2145 115	-	-	X	-	X	-	X
MRT 2260	-	X	X	X	X	-	X
MRT 2260 e	-	-	-	X	X	-	X
MRT 2545 115	-	-	X	-	X	-	X

NAC 2M	NAC 1.2 x 0.8 M	ORH	PF 1200 / 200 2P	PF 2000 / 365 3P	PF 2000 / 365	PS 2000 / 365 3P
--------	-----------------	-----	------------------	------------------	---------------	------------------

Machine compatibiliteit							
MRT 2570	-	X	X	X	X	-	X
MRT 2660	-	X	X	X	X	-	X
MRT 2660 e	-	-	-	X	X	-	X
MRT 3060	-	X	X	X	X	-	X
MRT 3570	-	X	X	X	X	-	X
MRT 3570 ES	-	X	X	X	X	-	X
MRT-X 1645	-	-	X	-	X	-	X
MRT-X 1845	-	-	X	-	X	-	X
MRT-X 2145	-	-	X	-	X	-	X
MRT-X 2260	-	X	X	X	X	-	X
MRT-X 2545	-	-	X	-	X	-	X
MRT-X 2570	-	X	X	X	X	-	X
MRT-X 2660	-	X	X	X	X	-	X
MRT-X 3060	-	X	X	X	X	-	X
MRT-X 3570	-	X	X	X	X	-	X
MRT-X 3570 ES	-	X	X	X	X	-	X
Referentienummer E-RECO 2	939240	-	-	-	52719658	52747069	-
MHT 790 ST5	-	-	-	-	X	-	-
MHT 10135 ST5	-	-	-	-	-	X	-
MHT 10160 ST5	-	-	-	-	-	X	-
MHT 10200 ST5	-	-	-	-	-	X	-
MHT 11250 ST5	-	-	-	-	-	X	-
MHT-X 790 Mining	-	-	-	-	X	-	-
MHT-X 790 ST3A	-	-	-	-	X	-	-
MHT-X 10135 ST3A	-	-	-	-	-	X	-
MHT-X 10160 ST3A	-	-	-	-	-	X	-
MHT-X 10200 ST3A	-	-	-	-	-	X	-
MHT-X 11250 ST3A	-	-	-	-	-	X	-
MRT 1645 75	-	-	-	-	X	-	-
MRT 1645 115	-	-	-	-	X	-	-
MRT 1845 75	-	-	-	-	X	-	-
MRT 1845 115	-	-	-	-	X	-	-
MRT 2145 115	-	-	-	-	X	-	-
MRT 2260	-	-	-	-	X	-	-
MRT 2260 e	-	-	-	-	X	-	-
MRT 2545 115	-	-	-	-	X	-	-
MRT 2570	-	-	-	-	X	-	-
MRT 2660	-	-	-	-	X	-	-
MRT 2660 e	-	-	-	-	X	-	-
MRT 3060	-	-	-	-	X	-	-
MRT 3570	-	-	-	-	X	-	-
MRT 3570 ES	-	-	-	-	X	-	-
MRT-X 1645	-	-	-	-	X	-	-
MRT-X 1845	-	-	-	-	X	-	-

NAC 2M	NAC 1.2 x 0.8 M	ORH	PF 1200 / 200 2P	PF 2000 / 365 3P	PF 2000 / 365	PS 2000 / 365 3P
--------	-----------------	-----	------------------	------------------	---------------	------------------

Machine compatibiliteit							
MRT-X 2145	-	-	-	-	X	-	-
MRT-X 2260	-	-	-	-	X	-	-
MRT-X 2545	-	-	-	-	X	-	-
MRT-X 2570	-	-	-	-	X	-	-
MRT-X 2660	-	-	-	-	X	-	-
MRT-X 3060	-	-	-	-	X	-	-
MRT-X 3570	-	-	-	-	X	-	-
MRT-X 3570 ES	-	-	-	-	X	-	-





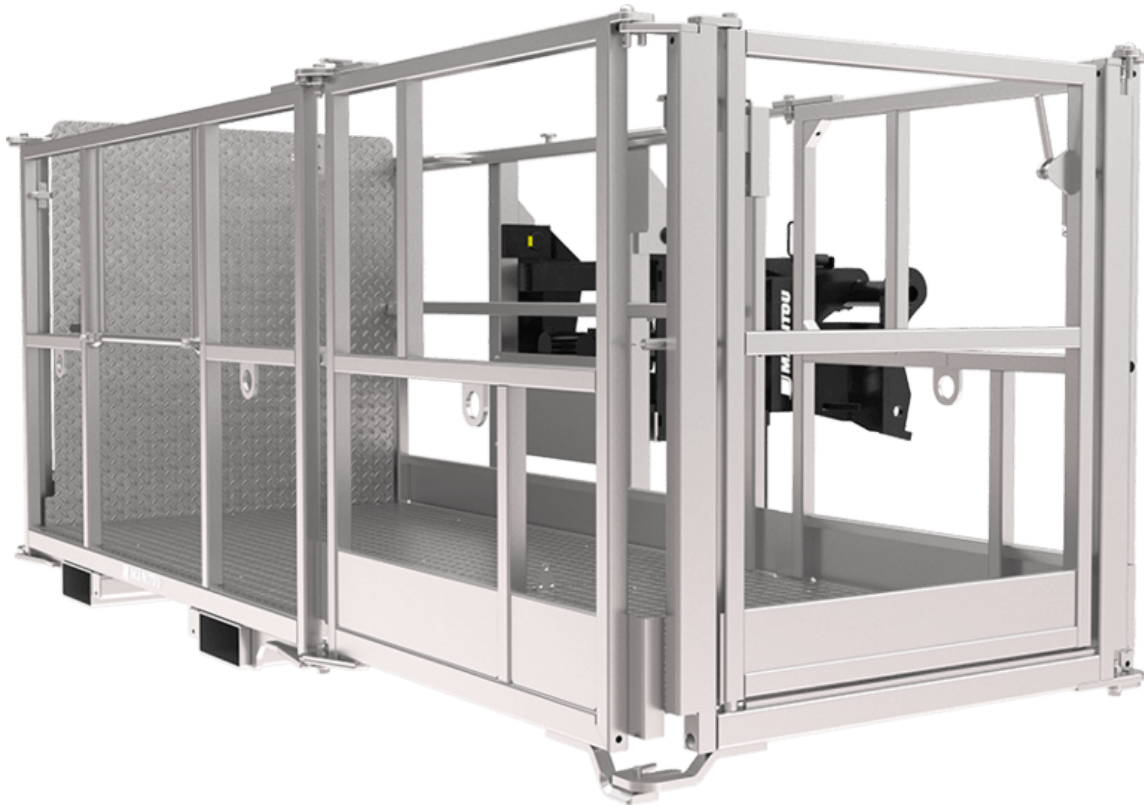

SNEL OPENENDE PLATFORM



- Capaciteit 365/1000/700 kg waaronder 3 personen.
- Werkbreedte uitgevouwen 4,4m.
- Pivoterende werkkooi +/- 90° langs beide zijden.
- Wettelijk toegestaan voor 3 personen.
- Toegankelijk langs 3 kanten (2 x zijkant + 1 front).
- "D" uitvoering: toegang rechts via zijdelingse deur.
- "DD" uitvoering: toegang vooraan en rechts via zijdelingse deur.
- Overbelastingssensor.
- Vorkbehuizingen: 238 mm x 100 mm.
- Flexibiliteit voor bovengrondse toepassingen.
- Eenvoudig openingssysteem, volledige opening/sluiting in 50 seconden.
- Zware en gegalvaniseerde structuur voor een langere levensduur.
- Stalen anti-slip bodem.
- Voorziening om het geheel te vervoeren met een palletvork op de werven.



	PSE 4400 / 365	PSE 4400 / 365 (MRT)	PSE 4400 / 365 D	PSE 4400 / 365 D (MRT)	PSE 4400 / 365 DD
Aantal personen	3	3	3	3	3
Capaciteit met personen inbegrepen (kg)	365	365	365	365	365
Gewicht (kg)	650	670	670	670	690
Totale hoogte (mm)	1300	1300	1300	1300	1312
Totale lengte (mm)	2430	2430	2430	2430	2261
Minimale breedte (mm)	2281	2281	2282	2282	2282
Maximale breedte (mm)	4388	4388	4388	4388	4348
Diepte (mm)	1150	1150	1150	1150	1150
Machine-apparatuur					
Rotatie 1	90	90	90	90	90
Rotatie 2	90	90	90	90	90

Machine compatibiliteit

Referentienummer	-	-	939021	-	53012073
MT 1135 HA Easy ST5	-	-	X	-	X
MT 1335 HA 75D ST5	-	-	X	-	X
MT 1335 HA 100D ST5	-	-	X	-	X
MT 1335 HA easy ST5	-	-	X	-	X
MT 1440 A	-	-	X	-	X
MT 1440 HA	-	-	X	-	X
MT 1840 A	-	-	X	-	X
MT 1840 HA	-	-	X	-	X
MT-X 1440 A	-	-	X	-	X
MT-X 1840 A	-	-	X	-	X
Referentienummer E-RECO	914500	52719248	939750	52686224	53012074
MRT 1645 75	X	X	X	X	X
MRT 1645 115	X	X	X	X	X
MRT 1845 75	X	X	X	X	X
MRT 1845 115	X	X	X	X	X
MRT 2145 115	X	X	X	X	X
MRT 2260	X	X	X	X	X
MRT 2260 e	-	X	-	X	-
MRT 2545 115	X	X	X	X	X
MRT 2570	X	X	X	X	X
MRT 2660	X	X	X	X	X
MRT 2660 e	-	X	-	X	-
MRT 3060	X	X	X	X	X
MRT 3570	X	X	X	X	X
MRT 3570 ES	X	X	X	X	X
MRT-X 1645	X	X	X	X	X
MRT-X 1845	X	X	X	X	X
MRT-X 2145	X	X	X	X	X
MRT-X 2260	X	X	X	X	X
MRT-X 2545	X	X	X	X	X

PSE 4400 / 365

PSE 4400 / 365 (MRT)

PSE 4400 / 365 D





PSE 4400 / 365 D (MRT)

PSE 4400 / 365 DD

Machine compatibiliteit

	PSE 4400 / 365	PSE 4400 / 365 (MRT)	PSE 4400 / 365 D	PSE 4400 / 365 D (MRT)	PSE 4400 / 365 DD
MRT-X 2570	X	X	X	X	X
MRT-X 2660	X	X	X	X	X
MRT-X 3060	X	X	X	X	X
MRT-X 3570	X	X	X	X	X
MRT-X 3570 ES	X	X	X	X	X
Referentienummer E-RECO 2	939241	52719665	-	-	-
MRT 1645 75	-	X	-	-	-
MRT 1645 115	-	X	-	-	-
MRT 1845 75	-	X	-	-	-
MRT 1845 115	-	X	-	-	-
MRT 2145 115	-	X	-	-	-
MRT 2260	-	X	-	-	-
MRT 2260 e	-	X	-	-	-
MRT 2545 115	-	X	-	-	-
MRT 2570	-	X	-	-	-
MRT 2660	-	X	-	-	-
MRT 2660 e	-	X	-	-	-
MRT 3060	-	X	-	-	-
MRT 3570	-	X	-	-	-
MRT 3570 ES	-	X	-	-	-
MRT-X 1645	-	X	-	-	-
MRT-X 1845	-	X	-	-	-
MRT-X 2145	-	X	-	-	-
MRT-X 2260	-	X	-	-	-
MRT-X 2545	-	X	-	-	-
MRT-X 2570	-	X	-	-	-
MRT-X 2660	-	X	-	-	-
MRT-X 3060	-	X	-	-	-
MRT-X 3570	-	X	-	-	-
MRT-X 3570 ES	-	X	-	-	-

VERPLICHTE UITRUSTING VAN MACHINES :  + 

	PSE 4400 / 365 DD (MRT)	PSE 4400 / 700 D	PSE 4400 / 700 D (MRT)	PSE 4400 / 1000 D	PSE 4400 / 1000 D (MRT)
Aantal personen	3	3	3	3	3
Capaciteit met personen inbegrepen (kg)	365	700	700	1000	1000
Gewicht (kg)	690	1030	1030	1030	1030
Totale hoogte (mm)	1312	1312	1312	1312	1312
Totale lengte (mm)	2261	2261	2261	2261	2261
Minimale breedte (mm)	2282	2282	2282	2282	2282
Maximale breedte (mm)	4348	4348	4348	4348	4348
Diepte (mm)	1150	1150	1150	1150	1150
Machine-apparatuur					
Rotatie 1	90	90	90	90	90
Rotatie 2	90	90	90	90	90

Machine compatibiliteit

Referentienummer	-	939023	-	939022	-
MT 1135 HA Easy ST5	-	X	-	X	-
MT 1335 HA 75D ST5	-	X	-	-	-
MT 1335 HA 100D ST5	-	X	-	-	-
MT 1335 HA easy ST5	-	X	-	X	-
MT 1440 A	-	X	-	X	-
MT 1440 HA	-	X	-	X	-
MT 1840 A	-	X	-	X	-
MT 1840 HA	-	X	-	X	-
MT-X 1440 A	-	X	-	X	-
MT-X 1840 A	-	X	-	X	-
Referentienummer E-RECO	52719250	939020	52719251	939500	52619610
MRT 1645 75	X	X	X	X	X
MRT 1645 115	X	X	X	X	X
MRT 1845 75	X	X	X	X	X
MRT 1845 115	X	X	X	X	X
MRT 2145 115	X	X	X	X	X
MRT 2260	X	X	X	X	X
MRT 2260 e	X	-	X	-	X
MRT 2545 115	X	X	X	X	X
MRT 2570	X	X	X	X	X
MRT 2660	X	X	X	X	X
MRT 2660 e	X	-	X	-	X
MRT 3060	X	X	X	X	X
MRT 3570	X	X	X	X	X
MRT 3570 ES	X	X	X	X	X
MRT-X 1645	X	X	X	X	X
MRT-X 1845	X	X	X	X	X
MRT-X 2145	X	X	X	X	X
MRT-X 2260	X	X	X	X	X
MRT-X 2545	X	X	X	X	X

PSE 4400 / 365 DD (MRT) | PSE 4400 / 700 D | PSE 4400 / 700 D (MRT) | PSE 4400 / 1000 D | PSE 4400 / 1000 D (MRT)

Machine compatibiliteit					
MRT-X 2570	X	X	X	X	X
MRT-X 2660	X	X	X	X	X
MRT-X 3060	X	X	X	X	X
MRT-X 3570	X	X	X	X	X
MRT-X 3570 ES	X	X	X	X	X
Referentienummer E-RECO 2	-	-	52719668	939242	52719669
MRT 1645 75	-	-	X	-	X
MRT 1645 115	-	-	X	-	X
MRT 1845 75	-	-	X	-	X
MRT 1845 115	-	-	X	-	X
MRT 2145 115	-	-	X	-	X
MRT 2260	-	-	X	-	X
MRT 2260 e	-	-	X	-	X
MRT 2545 115	-	-	X	-	X
MRT 2570	-	-	X	-	X
MRT 2660	-	-	X	-	X
MRT 2660 e	-	-	X	-	X
MRT 3060	-	-	X	-	X
MRT 3570	-	-	X	-	X
MRT 3570 ES	-	-	X	-	X
MRT-X 1645	-	-	X	-	X
MRT-X 1845	-	-	X	-	X
MRT-X 2145	-	-	X	-	X
MRT-X 2260	-	-	X	-	X
MRT-X 2545	-	-	X	-	X
MRT-X 2570	-	-	X	-	X
MRT-X 2660	-	-	X	-	X
MRT-X 3060	-	-	X	-	X
MRT-X 3570	-	-	X	-	X
MRT-X 3570 ES	-	-	X	-	X





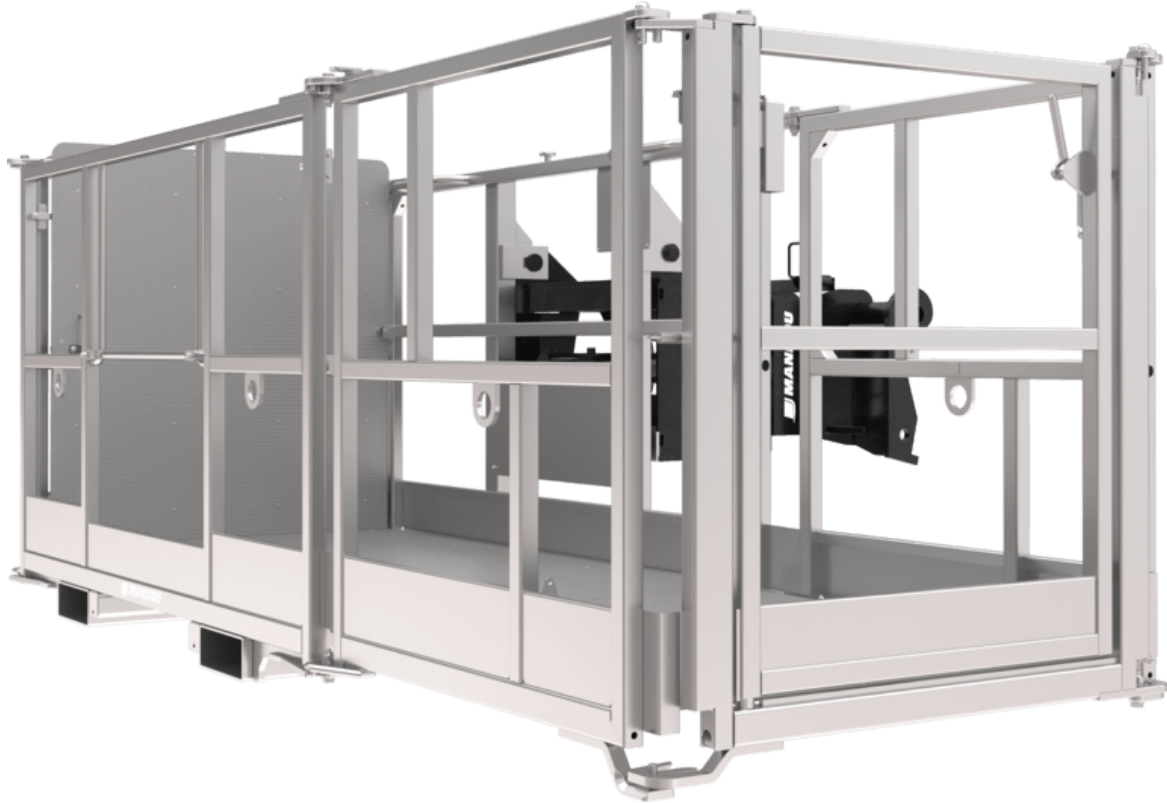

VERPLICHTE UITRUSTING VAN MACHINES :  + 



UITBREIDBAAR PLATFORM



- Capaciteit van 365 kg tot 1000 kg
- Draaibare werkkooi +/- 90°
- Gehomologeerd voor 3 personen
- Toegankelijk langs 3 zijden
- Overbelastingssensor.
- Flexibiliteit voor het optillen van personen.
- 2 verschillende werkbreedtes mogelijk.
- Een versterkte en gegalvaniseerde structuur voor een langere levensduur.
- Vloer in antislip metaal.
- De uitklapbare zijanten zijn onafhankelijk.
- Vorksleuven voor het verplaatsen van de werkkooi.

	NAC 2.45 / 5m 365 kg	NAC 2.45 / 5m 1000 kg	NAC 2.45 / 6m 365 kg	PSE 5000 / 365 D 3P	PSE 5000 / 1000 D 3P	PSE 6000 / 365 D 3P
Aantal personen	3	3	3	3	3	3
Capaciteit met personen inbegrepen (kg)	365	1000	365	365	1000	365
Gewicht (kg)	1020	1020	1090	1020	1020	1090
Totale hoogte (mm)	1289	1289	1307	1629	1629	1639
Totale lengte (mm)	2302	2302	2293	2302	2302	2293
Minimale breedte (mm)	2451	2451	2451	2451	2451	2451
Maximale breedte (mm)	4999	4999	5999	4999	4999	5999
Diepte (mm)	1120	1120	1120	1120	1120	1120
Machine-apparatuur						
Rotatie 1	90	90	90	90	90	90
Rotatie 2	90	90	90	90	90	90

Machine compatibiliteit

Referentienummer	-	788786	788784	-	-	-
MT 1335 HA 75D ST5	-	-	X	-	-	-
MT 1335 HA 100D ST5	-	-	X	-	-	-
MT 1440 A	-	X	X	-	-	-
MT 1440 HA	-	X	X	-	-	-
MT 1840 A	-	X	X	-	-	-
MT 1840 HA	-	X	X	-	-	-
MT-X 1440 A	-	X	X	-	-	-
MT-X 1840 A	-	X	X	-	-	-
Referentienummer E-RECO	921309	921308	921310	52719253	52719254	52719255
MRT 1645 75	X	X	X	X	X	X
MRT 1645 115	X	X	X	X	X	X
MRT 1845 75	X	X	X	X	X	X
MRT 1845 115	X	X	X	X	X	X
MRT 2145 115	X	X	X	X	X	X
MRT 2260	X	X	X	X	X	X
MRT 2260 e	-	-	-	X	X	X
MRT 2545 115	X	X	X	X	X	X
MRT 2570	X	X	X	X	X	X
MRT 2660	X	X	X	X	X	X
MRT 2660 e	-	-	-	X	X	X
MRT 3060	X	X	X	X	X	X
MRT 3570	X	X	X	X	X	X
MRT 3570 ES	X	X	X	X	X	X
MRT-X 1645	X	X	X	-	X	X
MRT-X 1845	X	X	X	X	X	X
MRT-X 2145	X	X	X	-	X	X
MRT-X 2260	X	X	X	X	X	X
MRT-X 2545	X	X	X	X	X	X
MRT-X 2570	X	X	X	X	X	X
MRT-X 2660	X	X	X	X	X	X

NAC 2.45 / 5m 365 kg	NAC 2.45 / 5m 1000 kg	NAC 2.45 / 6m 365 kg	PSE 5000 / 365 D 3P	PSE 5000 / 1000 D 3P	PSE 6000 / 365 D 3P
-------------------------	--------------------------	-------------------------	------------------------	-------------------------	------------------------

Machine compatibiliteit						
MRT-X 3060	X	X	X	X	X	X
MRT-X 3570	X	X	X	X	X	X
MRT-X 3570 ES	X	X	X	X	X	X
Referentienummer E-RECO 2	-	-	-	-	52719670	-
MRT 1645 75	-	-	-	-	X	-
MRT 1645 115	-	-	-	-	X	-
MRT 1845 75	-	-	-	-	X	-
MRT 1845 115	-	-	-	-	X	-
MRT 2145 115	-	-	-	-	X	-
MRT 2260	-	-	-	-	X	-
MRT 2260 e	-	-	-	-	X	-
MRT 2545 115	-	-	-	-	X	-
MRT 2570	-	-	-	-	X	-
MRT 2660	-	-	-	-	X	-
MRT 2660 e	-	-	-	-	X	-
MRT 3060	-	-	-	-	X	-
MRT 3570	-	-	-	-	X	-
MRT 3570 ES	-	-	-	-	X	-
MRT-X 1645	-	-	-	-	X	-
MRT-X 1845	-	-	-	-	X	-
MRT-X 2145	-	-	-	-	X	-
MRT-X 2260	-	-	-	-	X	-
MRT-X 2545	-	-	-	-	X	-
MRT-X 2570	-	-	-	-	X	-
MRT-X 2660	-	-	-	-	X	-
MRT-X 3060	-	-	-	-	X	-
MRT-X 3570	-	-	-	-	X	-
MRT-X 3570 ES	-	-	-	-	X	-



VERPLICHTE UITRUSTING VAN MACHINES :  + 

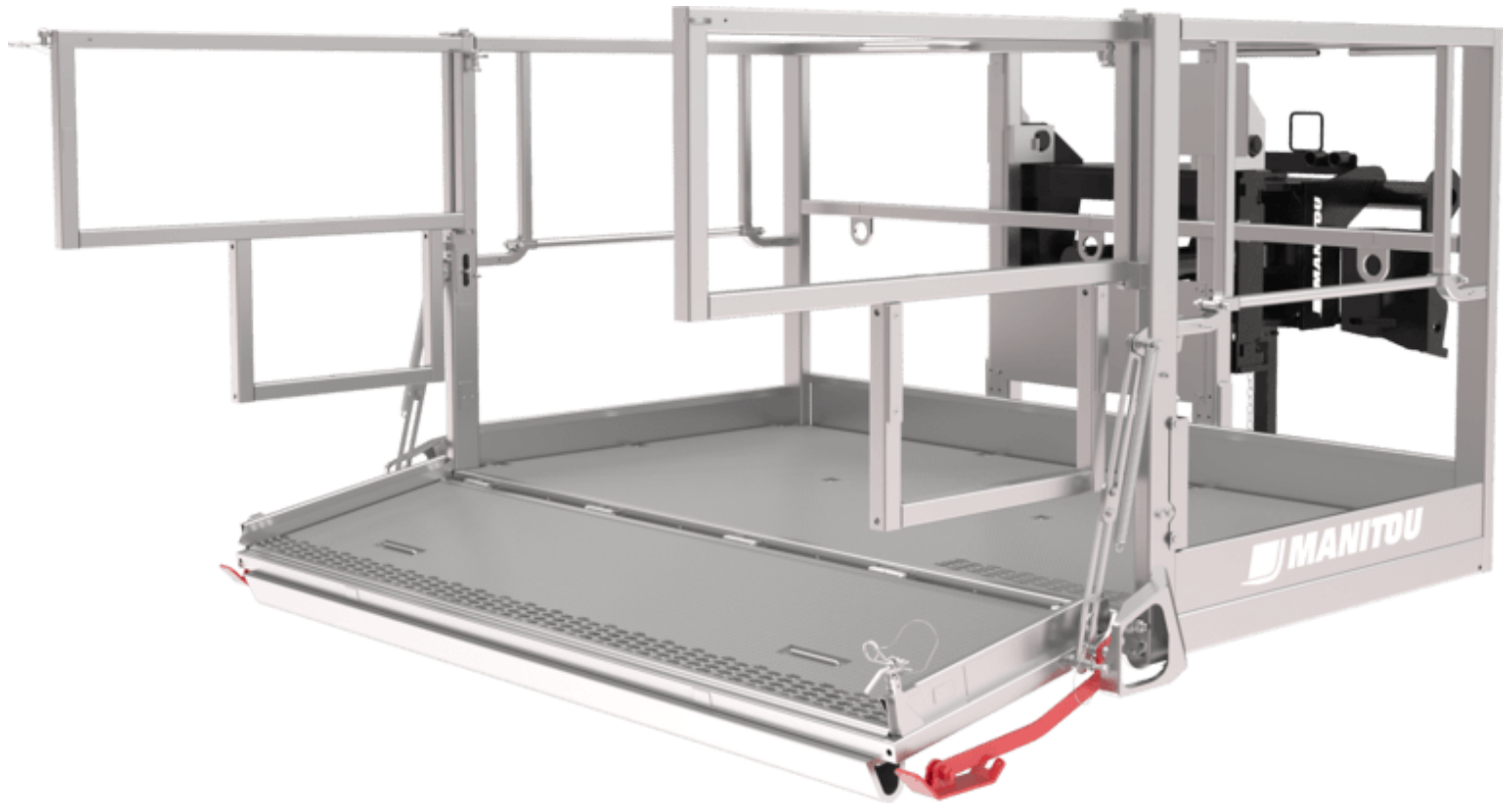

VAST ZWENKBARE DAKWERKERSKOOI



- Totale capaciteit van 1000 kg, waaronder 400 kg toegepast worden op het gedeelte in overhang.
- Werkkooi pivoterend op +/- 90° aan beide zijden.
- Wettelijke homologatie voor 3 personen.
- Aanwezigheidssensoren die elke beweging verbieden na de opening van de deur.
- Overbelastingssensor.
- Fysieke sensoren die die opening van de deur enkel toelaten bij contact met het dak.
- Innoverende werkkooi voor toepassingen in verband met dakbekleding en -onderhoud.
- Veilige platform.
- Anti-slip bodem.
- Gegalvaniseerde en versterkte structuur voor een langere levensduur.
- Werkkooi 2,3 x 1,2 m : mogelijkheid om een EURO-palet te laden.

	NC 2.3 x 1.2	PSR 2300 / 1000F 3P
Aantal personen	3	3
Capaciteit met personen inbegrepen (kg)	1000	1000
Gewicht (kg)	945	945
Totale hoogte (mm)	1307	1307
Totale lengte (mm)	2430	2430
Breedte (mm)	2404	2404
Diepte (mm)	1120	1120
Machine-apparatuur		
Rotatie 1	90	90
Rotatie 2	90	90

Machine compatibiliteit		
Referentienummer E-RECO	923323	52719261
MRT 1645 75	X	X
MRT 1645 115	X	X
MRT 1845 75	X	X
MRT 1845 115	X	X
MRT 2145 115	X	X
MRT 2260	X	X
MRT 2260 e	-	X
MRT 2545 115	X	X
MRT 2570	X	X
MRT 2660	X	X
MRT 2660 e	-	X
MRT 3060	X	X
MRT 3570	X	X
MRT 3570 ES	X	X
MRT-X 1645	X	X
MRT-X 1845	X	X
MRT-X 2145	X	X
MRT-X 2260	X	X
MRT-X 2545	X	X
MRT-X 2570	X	X
MRT-X 2660	X	X
MRT-X 3060	X	X
MRT-X 3570	X	X
MRT-X 3570 ES	X	X

VERPLICHTE UITRUSTING VAN MACHINES :  + 





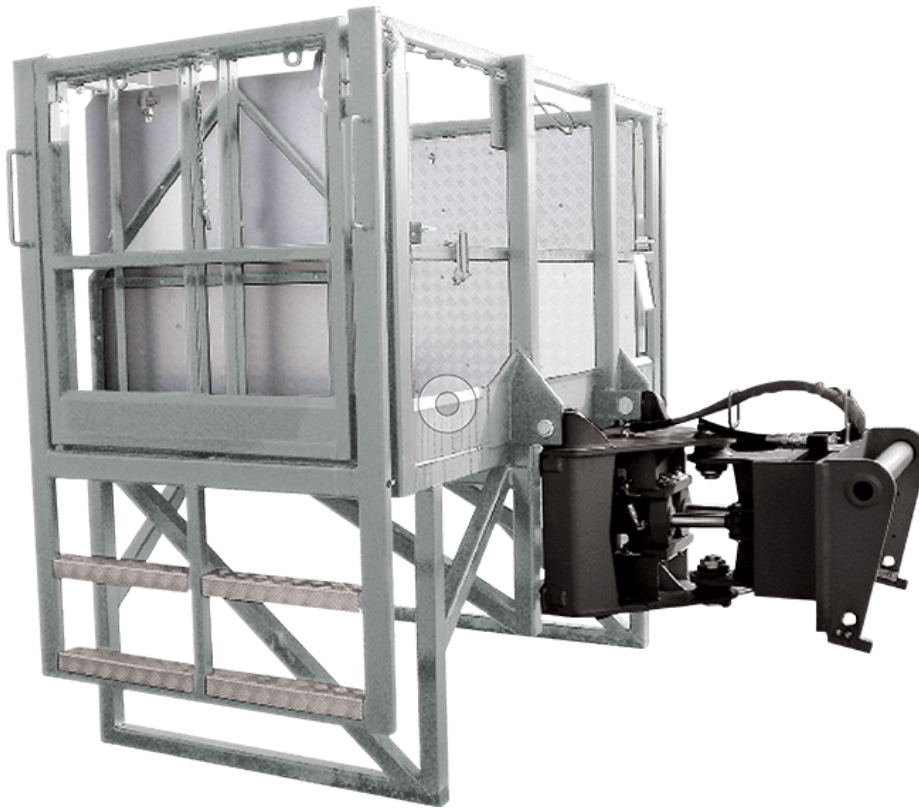

VERHOOGD UITBREIDBAAR PLATFORM



- Verhoogde werkkooi 55 cm pour de onder daktoepassingen.
- Orientatie aan 90°/90°.
- Verbreedbaar: 2,25-4 m breedte.
- Capaciteit 365 kg waaronder 3 personen.
- Toegang: specifieke trap + deur met openingssensor.
- Vorken: 238 mm x 100 mm.
- Ideale werkkooi om onder een dak of gebinte te werken : ze vermijft dat de arm van de machine de structuur raakt.
- Aanbevolen voor installaties achteraf : air conditioning, verlichting, plaatsen van kabels enz.



	PSE 4000 / 365D R	Raised platform 2.25-4m
Aantal personen	3	3
Capaciteit met personen inbegrepen (kg)	365	365
Gewicht (kg)	1100	1100
Totale hoogte (mm)	2409	2078
Totale lengte (mm)	2302	2228
Minimale breedte (mm)	2252	2252
Maximale breedte (mm)	4002	4002
Diepte (mm)	1120	1120
Machine-apparatuur	 + 	 + 
Rotatie 1	90	90
Rotatie 2	90	90

Machine compatibiliteit		
Referentienummer E-RECO	52719264	923343
MRT 1645 75	X	X
MRT 1645 115	X	X
MRT 1845 75	X	X
MRT 1845 115	X	X
MRT 2145 115	X	X
MRT 2260	X	X
MRT 2260 e	X	-
MRT 2545 115	X	X
MRT 2570	X	X
MRT 2660	X	X
MRT 2660 e	X	-
MRT 3060	X	X
MRT 3570	X	X
MRT 3570 ES	X	X
MRT-X 1645	X	X
MRT-X 1845	X	X
MRT-X 2145	X	X
MRT-X 2260	X	X
MRT-X 2545	X	X
MRT-X 2570	X	X
MRT-X 2660	X	X
MRT-X 3060	X	X
MRT-X 3570	X	X
MRT-X 3570 ES	X	X

VERPLICHTE UITRUSTING VAN MACHINES :  + 





WERKKOOI MET AFNEEMBAAR FOPS DAK

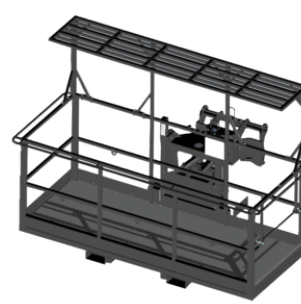
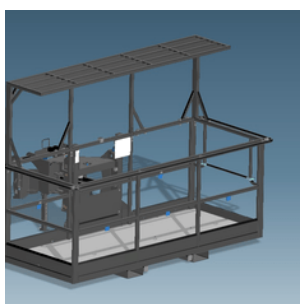
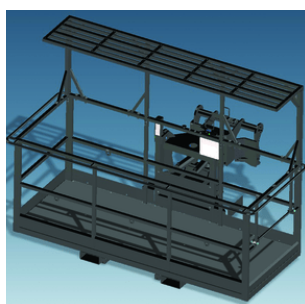

- Werkkooi uitgerust met een veiligheidsdak ontworpen volgens de standaard norm FOPS-1.
- Gehomologeerd voor 3 personen.
- Afneembaar dak.
- Rotatie 90°/90°.
- Werkkooi met een breedte van 3 m, niet verlengbaar.
- Vorken: 238 mm x 100 mm.
- Toegang: schuifstaaf.
- Totale veiligheid om personen te laten werken.
- Oplossing ontworpen voor mijnbouw- en tunneltoepassingen, waar het onmisbaar blijft om operatoren te beschermen.
- Afneembare veiligheidsdak type FOPS: maakt het mogelijk om de werkkooi als een standaard werkkooi te gebruiken als er geen bescherming vereist is.
- Voorziening om het geheel met een palletvork te vervoeren.



	PST 3000 / 1000	RF/P 3x1.2m 1000kg
Aantal personen	3	3
Capaciteit met personen inbegrepen (kg)	1000	1000
Gewicht (kg)	1105	1100
Totale hoogte (mm)	2140	2140
Totale lengte (mm)	2375	2375
Breedte (mm)	3190	3190
Machine-apparatuur	 + 	
Rotatie 1	90	90
Rotatie 2	90	90

Machine compatibiliteit		
Referentienummer E-RECO	52719263	921357
MRT 1645 75	X	X
MRT 1645 115	X	X
MRT 1845 75	X	X
MRT 1845 115	X	X
MRT 2145 115	X	X
MRT 2260	X	X
MRT 2260 e	X	-
MRT 2545 115	X	X
MRT 2570	X	X
MRT 2660	X	X
MRT 2660 e	X	-
MRT 3060	X	X
MRT 3570	X	X
MRT 3570 ES	X	X
MRT-X 1645	X	X
MRT-X 1845	X	X
MRT-X 2145	X	X
MRT-X 2260	X	X
MRT-X 2545	X	X
MRT-X 2570	X	X
MRT-X 2660	X	X
MRT-X 3060	X	X
MRT-X 3570	X	X
MRT-X 3570 ES	X	X

VERPLICHTE UITRUSTING VAN MACHINES :  + 



WERKKOOI MET LIER

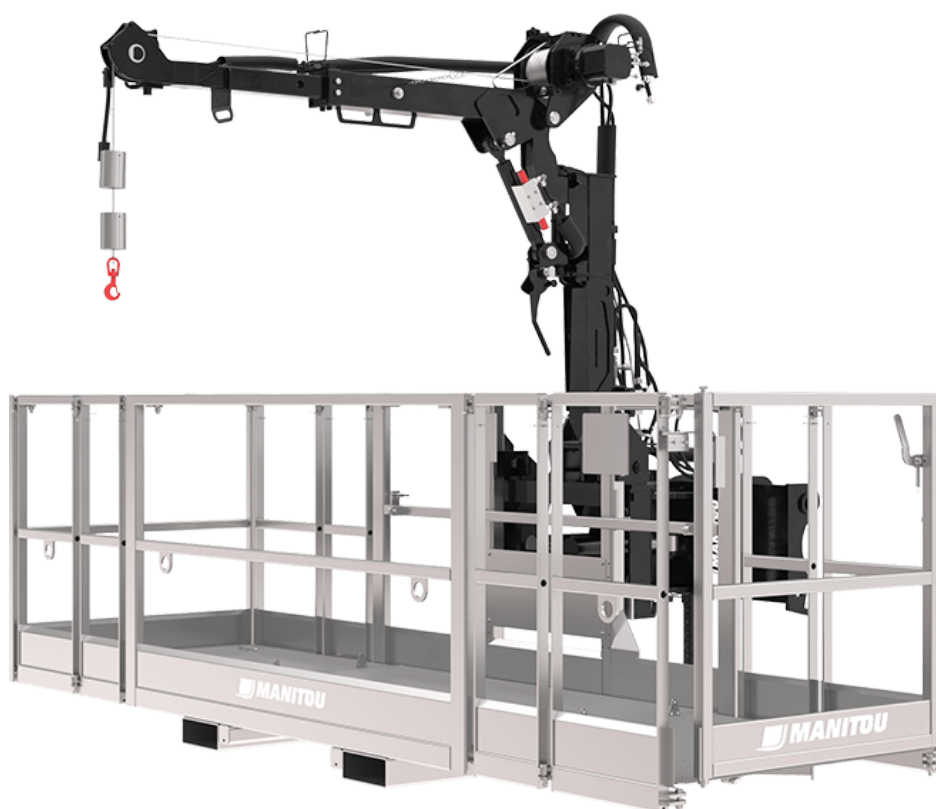

- 450 kg of 600 kg voor de werkkooi + 450 kg of 300 kg voor de lier = 900 kg capaciteit in totaal.
- 2 verschillende liercapaciteiten / koppel capaciteit voor de werkkooi.
- Hydraulisch lier bevestigd op de draaiende giek (manueel) ophebaar (hydraulisch) en telescopisch (manueel).
- Draaibare werkkooi +/- 90° langs beide kanten.
- Gehomologeerd voor 3 personen.
- Overbelastingssensor op de werkkooi & overbelastingssensor op de lier.
- Mouwen voor de verplaatsingen op de werf.
- Tyre changes made fast & safe.
- Significant improvement in tyre changing operations.
- No compromise with safety.
- As mobile as a human wrist.
- Wide range of diametres & capacities to suit all dump truck.
- Available on a wide range of machines.

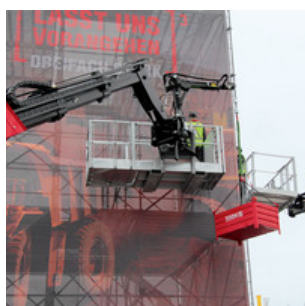

	NAC ARG 450kg / 450kg	NAC ARG 600kg / 300kg	ORH 3M 600kg / 300kg	PSE 3000 / 600D + W300 / 41M	PSE 4000 / 450D + W450 / 35M	PSE 4000 / 600D + W300 / 41M
Aantal personen	3	3	3	3	3	3
Capaciteit (kg)	450	300	300	300	450	300
Capaciteit met personen inbegrepen (kg)	450	600	600	600	450	600
Gewicht (kg)	1330	1330	1190	1200	1330	1330
Totale hoogte (mm)	2678	2743	2608	2608	2723	2708
Totale lengte (mm)	2206	2206	2301	2301	2261	2206
Kabellus	Direct	Direct	Direct	Direct	Direct	Direct
Minimale breedte (mm)	2259	2259	3190	3190	2281	2250
Maximale breedte (mm)	3993	3913	3190	3190	4387	3988
Diepte (mm)	1120	1120	1065	1065	1150	1150
Lengte kabel (mm)	35000	41000	30000	41000	35000	41000
Machine-apparatuur						
Rotatie 1	90	90	90	90	90	90
Rotatie 2	90	90	90	90	90	90

Machine compatibiliteit

Referentienummer E-RECO	914440	923336	53004852	52719256	52719258	52719257
MRT 1645 75	X	X	-	-	X	X
MRT 1645 115	X	X	-	-	X	X
MRT 1845 75	X	X	-	-	X	X
MRT 1845 115	X	X	-	-	X	X
MRT 2145 115	X	X	-	-	X	X
MRT 2260	X	X	X	X	X	X
MRT 2260 e	-	-	-	X	X	X
MRT 2545 115	X	X	-	-	X	X
MRT 2570	X	X	X	X	X	X
MRT 2660	X	X	X	X	X	X
MRT 2660 e	-	-	-	X	X	X
MRT 3060	X	X	X	X	X	X
MRT 3570	X	X	X	X	X	X
MRT 3570 ES	X	X	X	X	X	X
MRT-X 1645	X	X	-	-	X	X
MRT-X 1845	X	X	-	-	X	X
MRT-X 2145	X	X	-	-	X	X
MRT-X 2260	X	X	X	X	X	X
MRT-X 2545	X	X	-	-	X	X
MRT-X 2570	X	X	X	X	X	X
MRT-X 2660	X	X	X	X	X	X
MRT-X 3060	X	X	X	X	X	X
MRT-X 3570	X	X	X	X	X	X
MRT-X 3570 ES	X	X	X	X	X	X
Referentienummer E-RECO 2	939246	939245	-	-	-	5272781
MHT 10135 ST5	-	-	-	-	-	X
MHT 10160 ST5	-	-	-	-	-	X

NAC ARG 450kg / 450kg	NAC ARG 600kg / 300kg	ORH 3M 600kg / 300kg	PSE 3000 / 600D + W300 / 41M	PSE 4000 / 450D + W450 / 35M	PSE 4000 / 600D + W300 / 41M
-----------------------	-----------------------	----------------------	------------------------------	------------------------------	------------------------------

Machine compatibiliteit						
MHT 10200 ST5	-	-	-	-	-	X
MHT 11250 ST5	-	-	-	-	-	X
MHT-X 10135 ST3A	-	-	-	-	-	X
MHT-X 10160 ST3A	-	-	-	-	-	X
MHT-X 10200 ST3A	-	-	-	-	-	X
MHT-X 11250 ST3A	-	-	-	-	-	X

VERPLICHTE UITRUSTING VAN MACHINES :   + 

BETONSTORTBAKKEN

Bereik

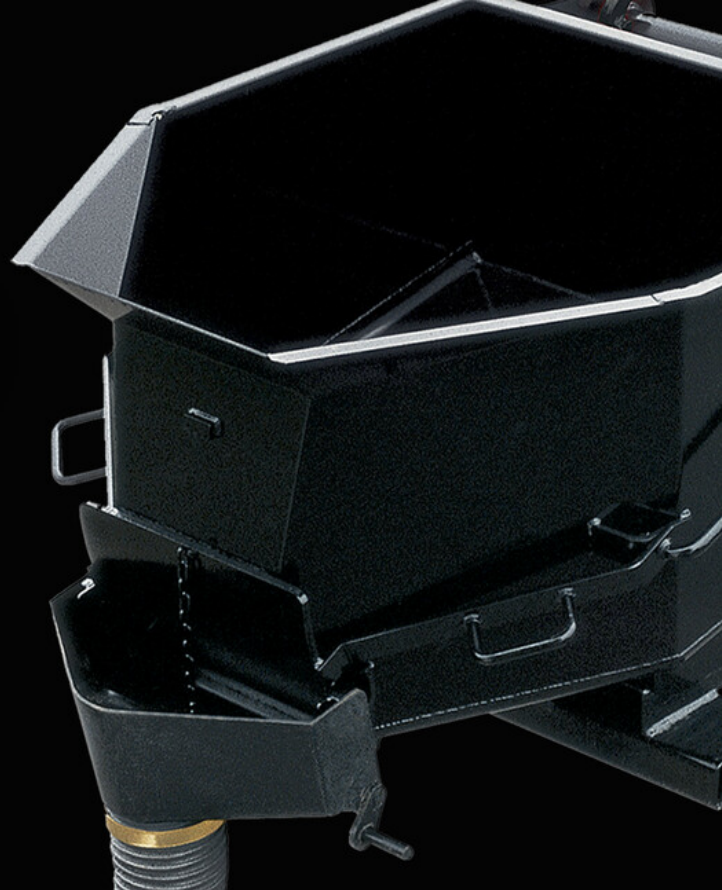

191 Betonkubel

194 Hijskubel



BETONKUBEL

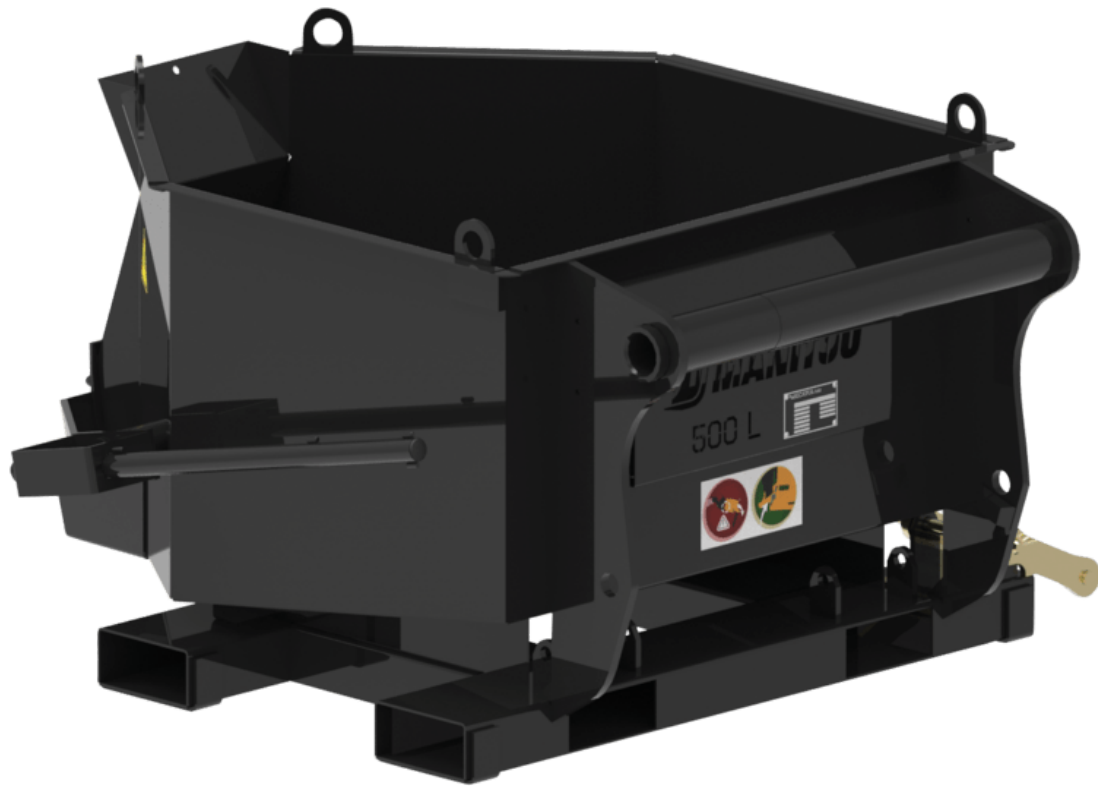

- Capaciteit 500 L.
- Opgebouwd op heftruck (vooraan positie) of op vorken (vlossen vooraan of zijdelings).
- Vorken: 170 x 75 mm.
- Veiligheid: accessoire uitgerust met een blokkeringsysteem voor de vorken.
- Goed beschermde componenten.
- BBHG 500 MRT : uitgerust met een stabilisatieklep.
- Bak aangepast aan de noden van de bouwvakkers.
- Compact werktuig om te kunnen werken in een vensteropening.
- Veelzijdig, voor beton en stabilisé.
- In optie: hydraulische opening voor een gecontroleerde verdeling ("H").
- In optie: flexibele trechter ("G") (1 m, ø 200 mm) voor een uitstekende nauwkeurigheid.



	BB 500	BB 500 MRT	BBG 500	BBH 500	BBHG 500	BBHG 500 MRT
Capaciteit (kg)	1200	1200	1200	1200	1200	1200
Capaciteit van de koepel (l)	500	500	500	500	500	500
Gewicht (kg)	191	191	201	200	210	211
Totale hoogte (mm)	776	776	776	776	776	776
Totale lengte (mm)	1466	1466	1466	1466	1466	1466
Breedte (mm)	1216	1216	1220	1110	1110	1110
Machine-apparatuur	✕	✕	✕	☺☺	☺☺	☺☺
Opening	Manual	Manual	Manual	Hydraulic	Hydraulic	Hydraulic
Flexibele buis	Nee	Nee	Nee	Nee	Ja	Nee

Machine compatibiliteit

Referentienummer	52000637	-	52000639	52000638	52000640	-
MT 420 H	X	-	-	X	-	-
MT 625 e	X	-	X	X	X	-
MT 625 HA	X	-	X	X	X	-
MT 730 H	X	-	X	X	X	-
MT 733 Easy	X	-	X	X	X	-
MT 735 75D ST5	X	-	X	X	X	-
MT 930 H	X	-	X	X	X	-
MT 930 HA	X	-	X	X	X	-
MT 933 Easy	X	-	-	-	X	-
MT 935 75D ST5	X	-	X	X	X	-
MT 1033 easy	X	-	X	X	X	-
MT 1135 75 D	X	-	X	X	X	-
MT 1135 H 100D	X	-	X	X	X	-
MT 1135 H easy ST5	X	-	X	X	X	-
MT 1135 ST5	X	-	X	X	X	-
MT 1335 75D ST5	X	-	X	X	X	-
MT 1335 100D ST5	X	-	X	X	X	-
MT 1335	X	-	X	X	X	-
MT 1335 H 75D ST5	X	-	X	X	X	-
MT 1335 H 100D ST5	X	-	X	X	X	-
MT 1335 HA 75D ST5	X	-	X	X	X	-
MT 1335 HA 100D ST5	X	-	X	X	X	-
MT 1335 ST5	X	-	X	X	X	-
MT 1440 A	X	-	X	X	X	-
MT 1440 HA	X	-	X	X	X	-
MT 1840 A	X	-	X	X	X	-
MT 1840 HA	X	-	X	X	X	-
MT-X 625 H	X	-	X	X	X	-
MT-X 1440	X	-	X	X	X	-
MT-X 1440 A	X	-	X	X	X	-
MT-X 1840	X	-	X	X	X	-
MT-X 1840 A	X	-	X	X	X	-
MXT 840 K	X	-	-	-	-	-

BB 500	BB 500 MRT	BBG 500	BBH 500	BBHG 500	BBHG 500 MRT
--------	------------	---------	---------	----------	--------------

Machine compatibiliteit						
MXT 840 P	X	-	-	-	-	-
MXT 1740 K	X	-	-	-	-	-
MXT 1740 P	X	-	-	-	-	-
Referentienummer E-RECO	-	52000642	-	-	-	52000643
MRT 1645 75	-	X	-	-	-	X
MRT 1645 115	-	X	-	-	-	X
MRT 1845 75	-	X	-	-	-	X
MRT 1845 115	-	X	-	-	-	X
MRT 2145 115	-	X	-	-	-	X
MRT 2260	-	X	-	-	-	X
MRT 2260 e	-	X	-	-	-	X
MRT 2545 115	-	X	-	-	-	X
MRT 2570	-	X	-	-	-	X
MRT 2660	-	X	-	-	-	X
MRT 2660 e	-	X	-	-	-	X
MRT 3060	-	X	-	-	-	X
MRT 3570	-	X	-	-	-	X
MRT 3570 ES	-	X	-	-	-	X
MRT-X 1645	-	X	-	-	-	X
MRT-X 1845	-	X	-	-	-	X
MRT-X 2145	-	X	-	-	-	X
MRT-X 2260	-	X	-	-	-	X
MRT-X 2545	-	X	-	-	-	X
MRT-X 2570	-	X	-	-	-	X
MRT-X 2660	-	X	-	-	-	X
MRT-X 3060	-	X	-	-	-	X
MRT-X 3570	-	X	-	-	-	X
MRT-X 3570 ES	-	X	-	-	-	X



HIJSKUBEL



- Vergrendelsysteem voor de vorken
- 3 aankoppelmogelijkheden (vorken 170 x 75 mm).
- Hydraulische opening van de klep beschikbaar op de 600 H uitvoering.
- Bescherming van de verbindingen en de hydraulische componenten.
- Breedte van de losklep : 540 mm.
- GL 600 H voor MRT : uitgerust met een stabilisatieklep.
- Veelzijdig: aanbouw op vorken of als hangend onderdeel.
- Bestudeerd zwaartepunt voor een grotere stabiliteit.
- Optimale vorm voor een doeltreffende verdeling.
- Onder de loep genomen ontwerp om de veiligheid van de operator en de bescherming van de componenten te optimaliseren.
- In optie: hydraulische opening ("H") voor een nauwkeurige en gecontroleerde verdeling.



	GL 400	GL 600	GL 600 H
Capaciteit (kg)	960	1440	1440
Capaciteit van de koepel (l)	400	600	600
Gewicht (kg)	185	227	245
Totale hoogte (mm)	1177	1197	1197
Totale lengte (mm)	856	995	995
Breedte (mm)	1139	1361	1326
Machine-apparatuur	✕	✕	⚙️
Opening	Manual	Manual	Hydraulic
Flexibele buis	Nee	Nee	Nee

Machine compatibiliteit

Referentienummer	52000527	52000528	52000529
MT 625 e	-	X	X
MT 625 HA	X	X	X
MT 730 H	-	X	X
MT 733 Easy	X	X	X
MT 735 75D ST5	-	X	X
MT 930 H	-	X	X
MT 930 HA	-	X	X
MT 933 Easy	-	X	X
MT 935 75D ST5	-	X	X
MT 1033 easy	X	X	X
MT 1135 75 D	-	X	X
MT 1135 H 100D	-	X	X
MT 1135 ST5	-	X	X
MT 1335 75D ST5	-	X	X
MT 1335 100D ST5	-	X	X
MT 1335 H 75D ST5	-	X	X
MT 1335 H 100D ST5	-	X	X
MT 1335 HA 75D ST5	-	X	X
MT 1335 HA 100D ST5	-	X	X
MT 1335 ST5	-	X	X
MT 1440 A	X	X	X
MT 1440 HA	X	X	X
MT 1840 A	X	X	X
MT 1840 HA	X	X	X
MT-X 625 H	X	X	X
MT-X 1440	X	X	X
MT-X 1440 A	X	X	X
MT-X 1840	X	X	X
MT-X 1840 A	X	X	X
MXT 840 K	X	-	X
MXT 840 P	X	-	X
MXT 1740 K	X	-	X
MXT 1740 P	X	-	X

GL 400	GL 600	GL 600 H
--------	--------	----------

Machine compatibiliteit			
Referentienummer E-RECO	-	52000528	52553617
MRT 1645 75	-	-	X
MRT 1645 115	-	-	X
MRT 1845 75	-	-	X
MRT 1845 115	-	-	X
MRT 2145 115	-	-	X
MRT 2260	-	X	X
MRT 2260 e	-	X	X
MRT 2545 115	-	-	X
MRT 2570	-	X	X
MRT 2660	-	X	X
MRT 2660 e	-	X	X
MRT 3060	-	X	X
MRT 3570	-	X	X
MRT 3570 ES	-	X	X
MRT-X 1645	-	-	X
MRT-X 1845	-	-	X
MRT-X 2145	-	-	X
MRT-X 2260	-	X	X
MRT-X 2545	-	-	X
MRT-X 2570	-	X	X
MRT-X 2660	-	X	X
MRT-X 3060	-	X	X
MRT-X 3570	-	X	X
MRT-X 3570 ES	-	X	X

VEEGMACHINES

Bereik



- 199 2-in-1 borstelmaschine
- 202 borstelmaschine met opvangbak
- 204 Hoge druk reiniger

- 206 Orienteerbare borstel (compacte machines)
- 208 Veegbak (compacte machines)



2-IN-1 BORSTELMACHINE



- Beschermd hydraulisch systeem, zonder retour naar de bak.
- Synchronisatieklep: vegen en de opvangbak controleren met één enkele hydraulische functie.
- Gegalvaniseerde structuur voor een langere levensduur.
- Synthetische bezem Ø 520 mm.
- Zijdelingse borstel Ø 320 mm in optie.
- Standaard uitvoering: standaard wielen, mechanische zijverstelling.
- "+" uitvoering : versterkte wielen, mechanische zijverstelling.
- "HWA +" uitvoering: versterkte wielen, hydraulische verstelling, watertoediening.
- Beperking MLA, MRT : Buitentemperatuur < 33°C, gebruik < 2 uur per dag.
- Eenvoudige en efficiënte oplossing voor lichte en halfzware veegtoepassingen.
- Opvangbak. Standaard wiel vooraan.
- Veegmachine met opvang en veegmachine



	SCC 2050	SCC 2050 +	SCC 2050 HWA +	SCC 2600	SCC 2600 +	SCC 2600 HWA +
Capaciteit van de koepel (l)	200	200	200	250	250	250
Gewicht (kg)	630	640	690	755	730	800
Totale hoogte (mm)	950	950	1550	950	950	1550
Totale lengte (mm)	2140	2170	2170	2140	2170	2170
Breedte (mm)	2270	2270	2270	2820	2820	2820
Machine-apparaat	☞☞	☞☞	☞☞	☞☞	☞☞	☞☞
Water sprayer and hydraulic swivel	Nee	Nee	Ja	Nee	Nee	Ja
Rotatie 1	30	30	30	30	30	30

Machine compatibiliteit

Referentienummer	52000514	52000516	52000518	52000515	52000517	52000519
ALT950	-	-	-	X	X	X
MHT 790 ST5	-	-	-	-	X	-
MHT-X 790 ST3A	-	-	-	-	X	-
MLA-T 533-145 V+ - ST5	-	X	-	X	X	X
MLT 420-60 H	X	X	X	-	-	-
MLT 625-75 H	X	X	X	-	-	-
MLT 635-130 PS+	-	-	-	X	X	X
MLT 635-140 V+	-	-	-	X	X	X
MLT 841-145 PS+	-	-	-	X	X	X
MLT 850-145 V+	-	-	-	X	X	X
MLT 940-140 V+	-	-	-	X	X	-
MLT 961-160 V+ L	-	-	-	X	-	X
MLT 1041-145 PS+L	-	-	-	X	X	X
MLT-X 625-75 H	X	X	X	-	-	-
MLT-X 732	-	-	-	X	X	X
MLT-X 735 T LSU	-	-	-	X	X	X
MLT-X 741 T LSU	-	-	-	X	X	X
MLT-X 841 - 145 PS+	-	-	-	X	X	X
MLT-X 850-145 V+	-	-	-	X	X	X
MLT-X 961-160 V+ L	-	-	-	X	-	X
MLT-X 1041-145 PS+L	-	-	-	X	X	X
MRT 1645 75	-	-	-	-	X	-
MRT 1645 115	-	-	-	-	X	-
MRT 1845 75	-	-	-	-	X	-
MRT 1845 115	-	-	-	-	X	-
MRT 2145 115	-	-	-	-	X	-
MRT 2545 115	-	-	-	-	X	-
MRT-X 1645	-	-	-	-	X	-
MRT-X 1845	-	-	-	-	X	-
MRT-X 2145	-	-	-	-	X	-
MRT-X 2545	-	-	-	-	X	-
MT 420 H	X	X	X	-	-	-
MT 625 e	X	X	X	-	-	-
MT 625 HA	X	X	X	-	-	-

SCC 2050	SCC 2050 +	SCC 2050 HWA +	SCC 2600	SCC 2600 +	SCC 2600 HWA +
----------	------------	----------------	----------	------------	----------------

Machine compatibiliteit						
MT 733 Easy	-	X	X	X	X	-
MT 735 75D ST5	-	-	-	X	X	X
MT 933 Easy	-	-	-	X	X	X
MT 935 75D ST5	-	-	-	X	X	X
MT 1033 easy	-	-	-	X	X	X
MT 1135 75 D	-	-	-	X	X	X
MT 1135 H 100D	-	-	-	X	X	X
MT 1135 H easy ST5	X	-	X	X	X	X
MT 1335 75D ST5	-	-	-	X	X	X
MT 1335 100D ST5	-	-	-	X	X	X
MT 1335	X	X	X	X	X	X
MT 1335 H 75D ST5	-	-	-	X	X	X
MT 1335 H 100D ST5	-	-	-	X	X	X
MT 1335 HA 75D ST5	-	-	-	X	X	X
MT 1335 HA 100D ST5	-	-	-	X	X	X
MT-X 625 H	X	X	X	-	-	-
MT-X 733	-	-	-	X	X	X
MT-X 1033	-	X	X	X	X	X

VERPLICHTE UITRUSTING VAN MACHINES : 





BORSTELMACHINE MET OPVANGBAK



- Vlottende kader om een verplettering van de accessoire te vermijden bij het werken op oneffen terrein.
 - Zijdelingse borstel in polyester van \varnothing 230mm in gegalvaniseerd staal.
 - Synchronisatieklep: vegen en de opvangbak controleren met één enkele hydraulische functie.
 - Drukbeugler voor krachtige accessoires.
 - Hoofdborstel met een \varnothing 600mm.
 - All-terrein wielen: 4x \varnothing 200mm.
 - Aanbevolen optie: continu oliedebiet.
- Economia de tempo nas manipulações de resíduos.
 - Acessório ideal para manipulação de materiais a granel (papel, resíduos verdes triturados, etc.).
 - Perfeito para trabalhar em concreto, asfalto, etc.
 - Caçamba reforçada para aplicações intensivas de resíduos.



	BRB 1600	BRB 2200	BRB 2500
Capaciteit van de koepel (l)	380	530	600
Gewicht (kg)	775	925	1000
Totale hoogte (mm)	1068	1068	1068
Totale lengte (mm)	2370	2370	2370
Breedte (mm)	2000	2600	2900
Machine-apparatuur			

Machine compatibiliteit			
Referentienummer	790313	790315	790316
MLT 625-75 H	X	-	-
MLT 635-130 PS+	-	X	-
MLT 635-140 V+	-	X	-
MLT 841-145 PS+	-	X	-
MLT 850-145 V+	-	X	-
MLT 961-160 V+ L	-	X	X
MLT 1041-145 PS+L	-	X	-
MLT-X 625-75 H	X	-	-
MLT-X 735 T LSU	-	X	-
MLT-X 741 T LSU	-	X	-
MLT-X 841 - 145 PS+	-	X	-
MLT-X 850-145 V+	-	X	-
MLT-X 961-160 V+ L	-	X	X
MLT-X 1041-145 PS+L	-	X	-
MT 625 e	X	-	-
MT 625 HA	X	-	-
MT-X 625 H	X	-	-

VERPLICHTE UITRUSTING VAN MACHINES :  + 



HOGE DRUK REINIGER



- Tankcapaciteit 600 L.
- Hydraulische waterpomp.
- Druk regelbaar tussen 10 en 200 bar.
- Standaard met manometer.
- Dop op houder, 40 m slang.
- Krachtige en doeltreffende reiniging.
- 45 min autonomie aan 200 bar.
- Smitkop op lans, 40 m darm.
- Aangepast aan alle reinigings- of onderhoudswerkzaamheden.
- Eenvoudige aankoppeling op de standaard vorken.



	VHPC 600
Capaciteit van de koepel (l)	600
Gewicht (kg)	240
Totale hoogte (mm)	1500
Totale lengte (mm)	1200
Breedte (mm)	1450
Lengte kabel (mm)	400
Machine-apparatuur	

Machine compatibiliteit	
Referentienummer	790335
MLT 635-130 PS+	X
MLT 635-140 V+	X
MLT 841-145 PS+	X
MLT 850-145 V+	X
MLT 961-160 V+ L	X
MLT 1041-145 PS+L	X
MLT-X 625-75 H	X
MLT-X 735 T LSU	X
MLT-X 741 T LSU	X
MLT-X 841 - 145 PS+	X
MLT-X 850-145 V+	X
MLT-X 961-160 V+ L	X
MLT-X 1041-145 PS+L	X









VERPLICHTE UITRUSTING VAN MACHINES :  + 



ORIENTEERBARE BORSTEL (COMPACTE MACHINES)



- Draaibaar 30 ° naar links/rechts.
- Veeg doeltreffend elk ondergrond om vuiligheid en stof te verwijderen.
- Robuust gebouwd, hydromotor met rechtstreekse aandrijving.

	SCA 1530	SCA 1680	SCA 1750	SCA 1850	SCA 1900	SCA 2080 (a)	SCA 2080 (b)	SCA 2140
Gewicht (kg)	400	410	390	420	400	410	410	-
Totale hoogte (mm)	684	684	684	684	684	684	684	-
Breedte (mm)	1753	1908	1753	2078	1908	2078	2078	2140
Diepte (mm)	1331	1331	1331	1331	1331	1331	1331	-
Machine-apparatuur								
Horizontal angle (°)	30	30	30	30	30	30	30	-

Machine compatibiliteit								
All-Tach® Narrow	N004040	-	-	-	-	-	-	-
All-Tach®	N004041	N004042	N51502366	N004043	N51502367	N51502370	N51502496	N51502055
4 point Carriage	N51502377	N51502378	-	N51502379	-	-	-	-
Euro Carriage	N51502381	N51502382	-	N51502383	-	-	-	-
1050 RT	-	-	X	-	X	-	-	-
1350 R NXT2	-	-	X	-	X	-	-	-
1350 RT	-	-	X	-	X	-	-	-
1650 R	-	-	-	-	X	-	-	-
1650 RT	-	-	X	-	X	-	-	-
1850 RT	-	-	-	-	-	-	-	X
1900 R	-	-	-	-	-	-	X	-
2150 RT	-	-	-	-	-	-	-	X
2200 R	-	-	-	-	-	-	X	-
2600 R	-	-	-	-	-	-	X	-
2700 V NXT:2	-	-	-	-	-	X	-	-
AL550	X	X	-	X	-	-	-	-
MLA 5-60 H-Z	X	X	-	X	-	-	-	-
R135	-	-	X	-	X	-	-	-
R165	-	-	-	-	X	-	-	-
R190	-	-	-	-	-	-	X	-
R220	-	-	-	-	-	-	X	-
R260	-	-	-	-	-	-	X	-
RT105	-	-	X	-	X	-	-	-
RT135	-	-	X	-	X	-	-	-
RT165	-	-	X	-	X	-	-	-
RT185	-	-	-	-	-	-	-	X
RT215	-	-	-	-	-	-	-	X
V270	-	-	-	-	-	X	-	-



VEEGBAK (COMPACTE MACHINES)

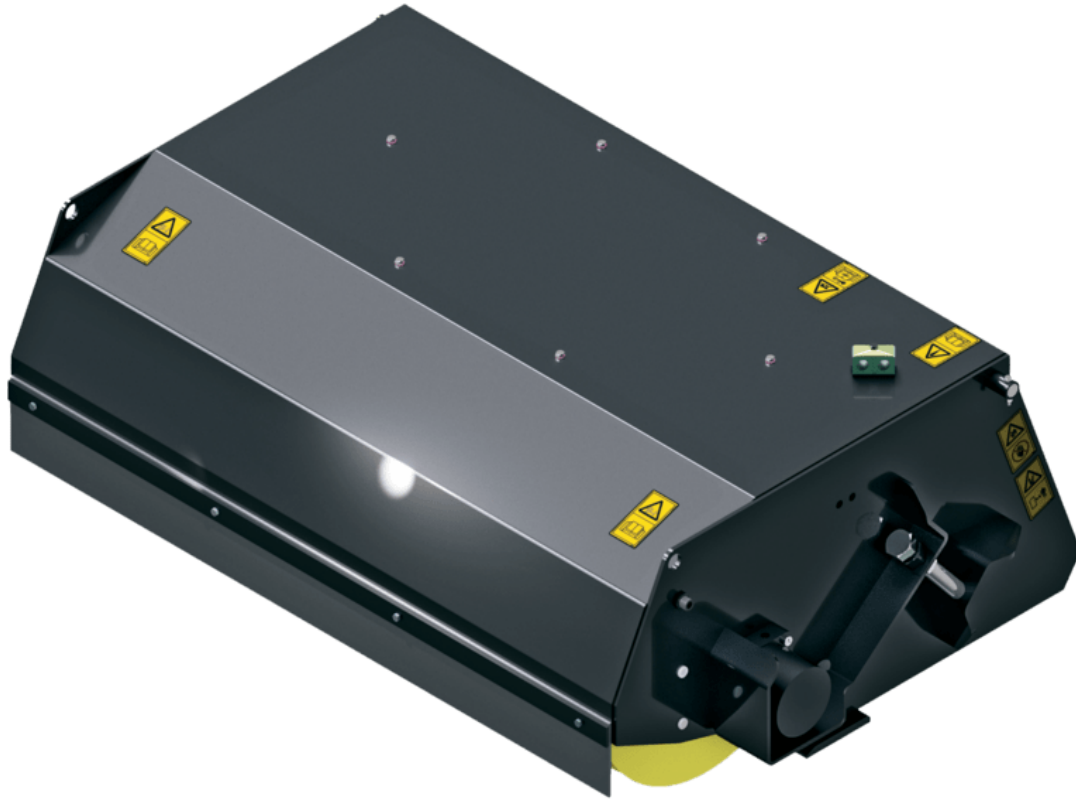





- Robuuste bouw en componenten deftig beschermd : bezemsecties in polypropyleen.
- Om te vegen en op te vegen in één werkgang.
- Op basis van een bak: het snijeffect kan worden gebruikt om gewikkelde materialen te verwijderen.

	SCB 1120 (b)	SCB 1370	SCB 1525 (a)	SCB 1525 (b)	SCB 1525 (c)	SCB 1680 (a)
Gewicht (kg)	235	310	346	346	374	430
Totale hoogte (mm)	652	652	652	652	637	690
Breedte (mm)	1376	1631	1776	1786	1737	1933
Diepte (mm)	1198	1222	1222	1222	1325	1308
Machine-apparatuur						
Working width - angled (mm)	1120	1370	1525	1525	1525	1680

Machine compatibiliteit						
All-Tach®	N726029	N736038	N004038	N736039	52715996	N747032
4 point Carriage	-	-	-	-	52741071	-
Euro Carriage	-	-	-	-	52741070	-
850 R	X	-	-	-	-	-
1050 R	-	X	-	X	-	-
1050 RT	-	X	-	X	-	-
1350 R NXT2	-	X	-	X	-	-
1350 RT	-	X	X	X	-	-
1640 E	X	-	-	-	-	-
1650 R	-	-	-	-	-	X
1650 RT	-	-	-	-	-	X
1900 R	-	-	-	-	-	X
AL230	X	-	-	-	-	-
AL320	X	-	-	-	-	-
AL330	X	-	-	-	-	-
GCT 3-14	-	-	-	-	X	-
GCT 3-14 +	-	-	-	-	X	-
MLA 2-25 H	X	-	-	-	-	-
MLA 3-25 H	X	-	-	-	-	-
MLA 3-25 H-C	X	-	-	-	-	-
MLA 5-50 H	-	-	-	X	-	-
R105	-	X	-	X	-	-
R135	-	X	-	X	-	-
R165	-	-	-	-	-	X
R190	-	-	-	-	-	X
RT105	-	X	-	X	-	-
RT135	-	X	-	X	-	-
RT165	-	-	-	-	-	X
ULM 412 H	-	-	-	-	X	-
ULM 412 H	-	-	-	-	X	-
ULM 415 H	-	-	-	-	X	-
ULM 415 H	-	-	-	-	X	-

VERPLICHTE UITRUSTING VAN MACHINES :

	SCB 1680 (b)	SCB 1850 (a)	SCB 1850 (b)	SCB 2080	SCB 2140
Gewicht (kg)	430	460	460	525	610
Totale hoogte (mm)	690	690	690	690	690
Breedte (mm)	1933	2100	2103	3053	2393
Diepte (mm)	1308	1313	1308	1308	1308
Machine-apparatuur					
Working width - angled (mm)	1680	1850	1850	2080	2140

Machine compatibiliteit					
All-Tach®	N51502049	N757045	N51502050	N700266	N51502051
4 point Carriage	-	-	-	-	-
Euro Carriage	-	-	-	-	-
1850 RT	X	-	X	-	-
2150 RT	-	-	X	-	X
2200 R	-	X	-	-	-
2600 R	-	X	-	X	-
2700 V NXT:2	-	X	-	X	-
3300 V NXT:2	-	X	-	X	-
4200 V	-	X	-	X	-
R220	-	X	-	-	-
R260	-	X	-	X	-
RT185	X	-	X	-	-
RT215	-	-	X	-	X
V270	-	X	-	X	-
V330	-	X	-	X	-

VERPLICHTE UITRUSTING VAN MACHINES : 

LIEREN

Bereik



- 213 Hydraulische lier
- 216 Hydraulische lier voor zware lasten

- 218 Vario-lier







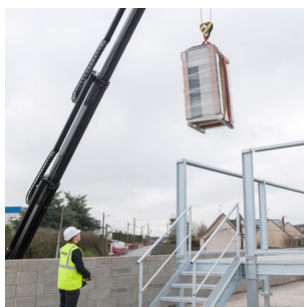

HYDRAULISCHE LIER



- Hydraulische motor + automatische stop van de bewegingen van de kabel.
- Negatieve breekkracht door oliebad.
- Dubbele of viervoudige lijntrekkraft (volgens het type).
- Gehomologeerde draaiende haak met automatische vergrendeling.
- Nota : de afmetingen hieronder gelden voor een lier geplaatst op de steunen.
- Transformeert uw verreiker in een kraan.
- Heel snel werkzaam met het Manitou snelkoppelsysteem.
- Gemakkelijk te bedienen vanuit de cabine of met de afstandsbediening van de machine.
- Snelle en precieze bewegingen.



	W 3000 / 36M	W 3000 DI / 46M	W 6000 / 32M	Winch 3T	Winch 3T MRT	Winch 3T TD	Winch 5T
Max. bereik (mm)	515	689	542	519	515	689	541
Werkhoogte (mm)	36000	46000	32000	24000	33000	46000	24000
Capaciteit (kg)	3000	3000	6000	3000	3000	3000	5000
Gewicht (kg)	305	490	439	310	320	400	420
Totale hoogte (mm)	1803	1803	1803	1869	1868	1869	1869
Totale lengte (mm)	900	900	900	900	900	900	900
Kabellus	1	Direct	1	1	1	Direct	1
Breedte (mm)	1080	1080	1080	1080	1080	1080	1080
Diepte (mm)	763	838	838	763	763	838	838
Lengte kabel (mm)	75000	48000	67000	49000	70000	49000	53000
Machine-apparatuur							
Hoeksnelheid (m/mn)	27	35	17	15	15	30	14

Machine compatibiliteit

Referentienummer	-	-	-	885236	-	-	-
MT 735 75D ST5	-	-	-	X	-	-	-
MT 935 75D ST5	-	-	-	X	-	-	-
MT 1135 75 D	-	-	-	X	-	-	-
MT 1135 H 100D	-	-	-	X	-	-	-
MT 1135 H easy ST5	-	-	-	X	-	-	-
MT 1335 75D ST5	-	-	-	X	-	-	-
MT 1335 100D ST5	-	-	-	X	-	-	-
MT 1335	-	-	-	X	-	-	-
MT 1335 H 75D ST5	-	-	-	X	-	-	-
MT 1335 H 100D ST5	-	-	-	X	-	-	-
MT 1335 HA 75D ST5	-	-	-	X	-	-	-
MT 1335 HA 100D ST5	-	-	-	X	-	-	-
MT 1440 A	-	-	-	X	-	-	-
MT 1440 HA	-	-	-	X	-	-	-
MT 1840 A	-	-	-	X	-	-	-
MT 1840 HA	-	-	-	X	-	-	-
MT-X 1440	-	-	-	X	-	-	-
MT-X 1440 A	-	-	-	X	-	-	-
MT-X 1840	-	-	-	X	-	-	-
MT-X 1840 A	-	-	-	X	-	-	-
Referentienummer E-RECO	52717650	52717900	52717351	921337	939393	939111	921341
MRT 1645 75	X	X	X	X	X	X	X
MRT 1645 115	X	X	X	X	X	X	X
MRT 1845 75	X	X	X	X	X	X	X
MRT 1845 115	X	X	X	X	X	X	X
MRT 2145 115	X	X	X	X	X	X	X
MRT 2260	X	X	X	X	X	X	X
MRT 2260 e	-	X	-	-	-	-	-
MRT 2545 115	X	X	X	X	X	X	X
MRT 2570	X	X	X	X	X	X	X

W 3000 / 36M	W 3000 DI / 46M	W 6000 / 32M	Winch 3T	Winch 3T MRT	Winch 3T TD	Winch 5T
--------------	-----------------	--------------	----------	--------------	-------------	----------

Machine compatibiliteit							
MRT 2660	X	X	X	X	X	X	X
MRT 2660 e	X	X	X	-	-	-	-
MRT 3060	X	X	X	X	X	X	X
MRT 3570	X	X	X	X	X	X	X
MRT 3570 ES	X	X	X	X	X	X	X
MRT-X 1645	X	X	X	X	X	X	X
MRT-X 1845	X	X	X	X	X	X	X
MRT-X 2145	X	X	X	X	X	X	X
MRT-X 2260	X	X	X	X	X	X	X
MRT-X 2545	X	X	X	X	X	X	X
MRT-X 2570	X	X	X	X	X	X	X
MRT-X 2660	X	X	X	X	X	X	X
MRT-X 3060	X	X	X	X	X	X	X
MRT-X 3570	X	X	X	X	X	X	X
MRT-X 3570 ES	X	X	X	X	X	X	X







VERPLICHTE UITRUSTING VAN MACHINES :  + 



HYDRAULISCHE LIER VOOR ZWARE LASTEN



- Hydraulische aandrijving met automatische stop op het einde van de koers.
- Negatieve rem voor een verhoogde veiligheid.
- Poelie op enkele of dubbele ring.
- Gehomologeerde automatische haak met wartel.
- Liersteun voor stockage om de vorken te kunnen verplaatsen.
- Nota : de afmetingen hieronder gelden voor een lier geplaatst op de steunen.
- Soluzione semplice e leggera per gestire carichi sospesi.
- Perfetto per il trasporto e il posizionamento di travi, cornici e altri elementi leggeri e voluminosi
- Il suo design consente di raggiungere aree strette e migliora anche la portata in avanti del sollevatore telescopico.
- Struttura tubolare progettata per un rapporto peso / rigidità ottimale

	W 13500 / 13	W 16000 / 13	W 20000 / 14	W 25000 / 14	Winch 9 T	Winch 23 T
Max. bereik (mm)	682	682	722	722	532	722
Werkhoogte (mm)	13000	13000	14000	14000	14000	14000
Capaciteit (kg)	13500	16000	20000	25000	9000	23000
Gewicht (kg)	1185	1185	1450	1450	850	1550
Totale hoogte (mm)	2328	2328	2623	2623	2259	2623
Totale lengte (mm)	1200	1200	1200	1200	1200	1200
Kabellus	2	2	2	2	1	2
Breedte (mm)	1250	1250	1250	1250	1250	1250
Diepte (mm)	975	975	1044	1044	975	1044
Lengte kabel (mm)	60000	60000	60000	60000	30000	60000
Machine-apparatuur						
Hoeksnelheid (m/mn)	-	-	-	-	22.50	12

Machine compatibiliteit

Referentienummer E-RECO	52702240	52702241	52702470	52693990	939030	939329
MHT 790 ST5	-	-	-	-	X	-
MHT 10135 ST5	X	-	-	-	-	-
MHT 10160 ST5	-	X	-	-	-	-
MHT 10200 ST5	-	-	X	-	-	-
MHT 11250 ST5	-	-	-	X	-	-
MHT 12330	-	-	-	-	-	X
MHT-X 790 Mining	-	-	-	-	X	-
MHT-X 790 ST3A	-	-	-	-	X	-
MHT-X 11250 Mining	-	-	-	-	-	X
MHT-X 12330	-	-	-	-	-	X

VERPLICHTE UITRUSTING VAN MACHINES :  + 





VARIO-LIER



- Automatische stop van de beweging bij het einde van de kabel en einde van het oprollen.
 - Negatieve rem.
 - Gepatenteerd concept met variabele hydraulische snelheid.
 - Automatische aanpassing van de senlehti in functie van de last en de operatoreisen door gepatenteerd hydraulisch systeem.
 - Gehomologeerde zelfblokkerende draaihaak.
 - Basis van de lier met behuizing voor vorken om het geheel te kunnen verplaatsen op de werf of op een vrachtwagen te laden.
 - Gewicht: 700 kg.
 - Opmerking: de vermelde afmetingen gelden voor een op de basis geplaatste lier.
 - MRT Vision+ : aanzienlijke toename van de haaksnelheid door verbetering van de samenwerking tussen machine en aanbouwdelen.
 - Beperkte capaciteit v
- Verandert uw verreiker in een volwaardige mobiele kraan.
 - 4x sneller dan een standaard lier 5t / 3x neller dan een standaard lier 3t.
 - Traploze aanpassing van de snelheid van de haak in functie van de last en de operator.
 - Eenvoudige controle vanuit de cabine of via de afstandsbediening van de machine (optie).



	VARIOWINCH 7.2 t	W 7200 V
Max. bereik (mm)	238	238
Werkhoogte (mm)	36000	36000
Capaciteit (kg)	7200	7200
Gewicht (kg)	776	700
Totale hoogte (mm)	2408	2408
Totale lengte (mm)	1200	1200
Kabellus	1	1
Breedte (mm)	1223	1223
Diepte (mm)	638	638
Lengte kabel (mm)	76000	76000
Machine-apparatuur		
Hoeksnelheid (m/mn)	60.60	60.60

Machine compatibiliteit		
Referentienummer E-RECO	52576737	52735674
MRT 2260	X	X
MRT 2260 e	-	X
MRT 2570	X	X
MRT 2660	X	X
MRT 2660 e	-	X
MRT 3060	X	X
MRT 3570	X	X
MRT 3570 ES	X	X
MRT-X 2260	X	X
MRT-X 2570	X	X
MRT-X 2660	X	X
MRT-X 3060	X	X
MRT-X 3570	X	X
MRT-X 3570 ES	X	X

VERPLICHTE UITRUSTING VAN MACHINES :  + 

MIJNBOUWACCESSOIRES

Bereik

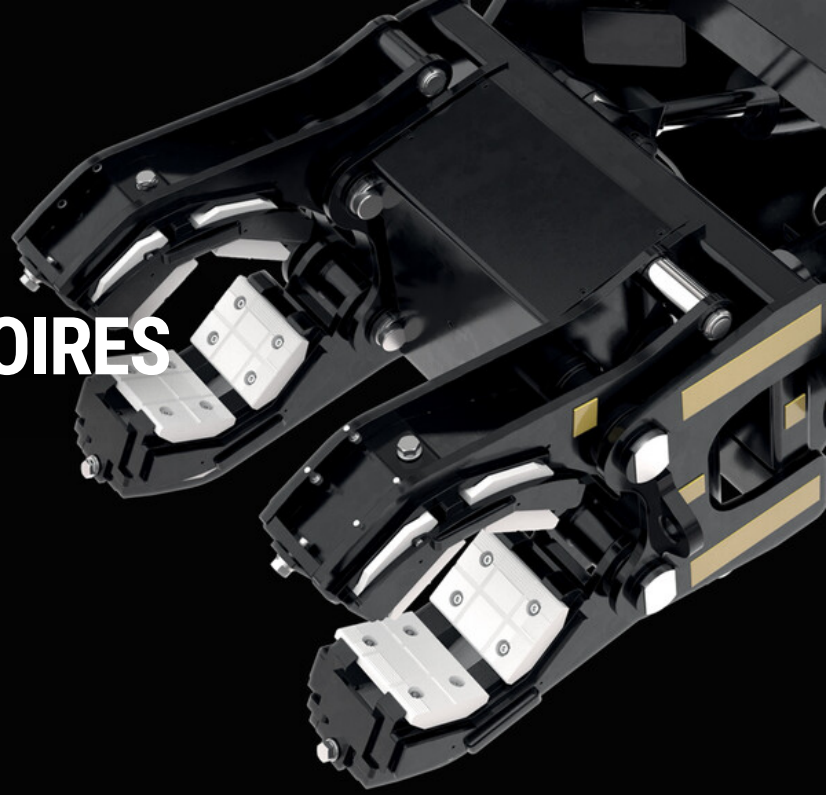

222 Buizenklem

224 Tunnel werkkooi met FOPS dak





BUIZENKLEM



- Maximale capaciteit 14 000 kg / 30 865 lbs.
- Maximaal diameter van de buis 1016 mm.
- Verhoogde bescherming van de componenten om de stilstanden te beperken.
- Volledige opening van de grijper, verhoogde doeltreffendheid bij het laden van paletten.
- Tandbekledingen omringd met rubber.
- Afmetingen van de vorken : 120 x 240 x 2400 mm / 4.7 x 9.4 x 94.5".
- Smallere vorken (90 mm) zijn beschikbaar op aanvraag.
- De vorken kunnen zowel in vaste als vlottende uitvoering gebruikt worden.
- Verhoogt de veiligheid en het werkrendement in toepassingen waar buizen moeten vervoerd worden.
- Perfecte houding van de buizen dankzij een mobiele grijper met hydraulische tanden.
- "De appendix" op het uiteinde van de grijper verzekert een complete sluiting en vermijdt dat buizen gaan schuiven.
- Onafhankelijke controle van de steunen van de grijper en de tanden, voor een verhoogde nauwkeurigheid.
- Grotere veelzijdigheid: kan worden gebruikt om ander lasten te manipuleren.



	PH 2100 / 8000	PH 2500 / 14000
Capaciteit (kg)	8000	14000
Gewicht (kg)	2200	3800
Totale lengte (mm)	2143	3104
Vorkgedeelte X Breedte vorken X Lengte vorken (mm)	70 X 260 X 1200	120 X 240 X 2400
Breedte (mm)	2115	2444
Gesloten grijphoogte (mm)	1387	2068
Geopende grijphoogte (mm)	3286	4699
Diameter minimum / Diameter maximum (mm)	566 / 850	0 / 1016
Machine-apparatuur		

Machine compatibiliteit		
Referentienummer E-RECO	939231	939332
MHT 790 ST5	X	-
MHT 10135 ST5	X	-
MHT 10160 ST5	X	-
MHT 10200 ST5	X	X
MHT 11250 ST5	-	X
MHT 12330	X	X
MHT-X 790 Mining	X	-
MHT-X 790 ST3A	X	-
MHT-X 10135 ST3A	X	-
MHT-X 10160 ST3A	X	-
MHT-X 10200 ST3A	X	X
MHT-X 11250 Mining	-	X
MHT-X 11250 ST3A	-	X
MHT-X 12330	X	X

VERPLICHTE UITRUSTING VAN MACHINES :  + 



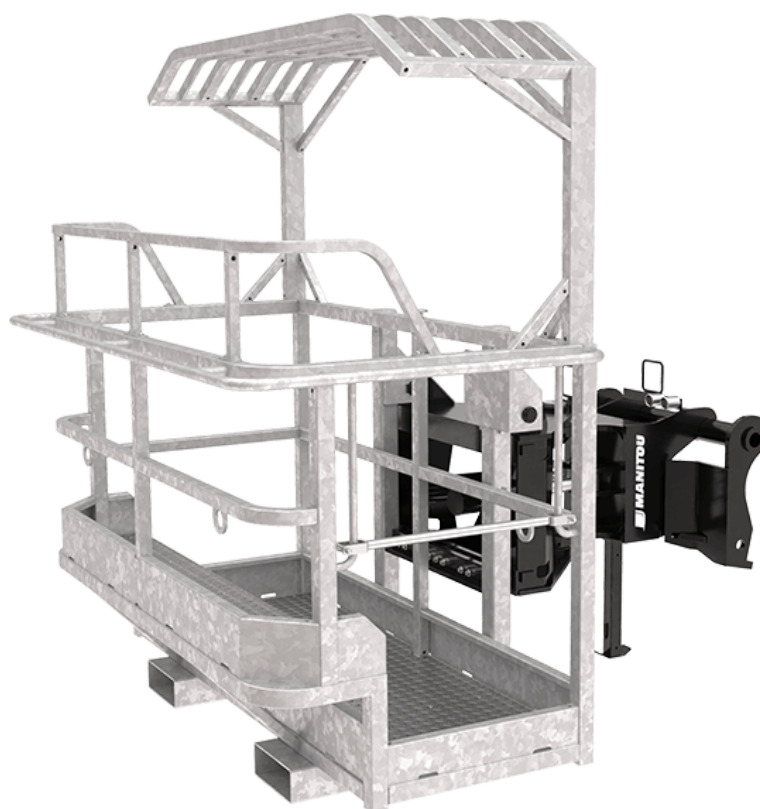

TUNNEL WERKKOOI MET FOPS DAK



- Dak type FOPS (diepte: 580 mm / volledige breedte van de werkkooi / hoogte onder dak 1930 mm).
- Beschermede verhooggedeelte (+ 300 mm) om boven het dak te kunnen in alle veiligheid.
- Capaciteit 1000 kg.
- Rotatie 90° aan beide zijden.
- Toegang: schuifstaaf van één kant.
- Vorkenbehuizing voor verplaatsingen op de werf.
- Maximale bescherming voor tunneltoepassingen.
- Men hoeft zich niet meer buiten de kooi te bukken of boven te kruipen om boven het FOPS-dak te werken.
- Mogelijkheid om zware werktuigen mee te nemen in de werkkooi.
- Geen toegevingen op gebied van veiligheid: voldoet aan de EN280-norm.



	GALLERY PLATFORM	PST 1800 / 1000 3P FOPS1
Aantal personen	3	3
Capaciteit (kg)	1000	1000
Gewicht (kg)	730	730
Totale hoogte (mm)	2125	2125
Totale lengte (mm)	2175	2175
Breedte (mm)	1990	1990
Diepte (mm)	1000	1000
Machine-apparatuur		
Rotatie 1	90	90
Rotatie 2	90	90

Machine compatibiliteit		
Referentienummer	-	52574289
MT-X 1033 A Mining	-	X
Referentienummer E-RECO	921356	52719262
MHT 790 ST5	-	X
MHT 10135 ST5	-	X
MHT 10160 ST5	-	X
MHT 10200 ST5	-	X
MHT 11250 ST5	-	X
MHT-X 790 Mining	-	X
MHT-X 790 ST3A	-	X
MHT-X 10135 ST3A	-	X
MHT-X 10160 ST3A	-	X
MHT-X 10200 ST3A	-	X
MHT-X 11250 ST3A	-	X
MRT 1645 75	X	X
MRT 1645 115	X	X
MRT 1845 75	X	X
MRT 1845 115	X	X
MRT 2145 115	X	X
MRT 2260	X	X
MRT 2260 e	-	X
MRT 2545 115	-	X
MRT 2570	X	X
MRT 2660	X	X
MRT 2660 e	-	X
MRT 3060	X	X
MRT 3570	X	X
MRT 3570 ES	X	X
MRT-X 1645	X	X
MRT-X 1845	X	X
MRT-X 2145	X	X
MRT-X 2260	X	X
MRT-X 2545	-	X

	GALLERY PLATFORM	PST 1800 / 1000 3P FOPS1
Machine compatibiliteit		
MRT-X 2570	X	X
MRT-X 2660	X	X
MRT-X 3060	X	X
MRT-X 3570	X	X
MRT-X 3570 ES	X	X

VERPLICHTE UITRUSTING VAN MACHINES : 

EARTH DRILLING AND DIGGING SOLUTIONS

Bereik



229 Hydraulische hamer (Compacte machines)



HYDRAULISCHE HAMER (COMPACTE MACHINES)



- Hogere weerstand, kader en hydrauliek.
- Hogere impact- en slagvermogen.
- Tover uw machine in een ware breekunit. Stille versie standaard.

	H 88	H 90	H 160	H 162	H 240	H 330	H 570
Gewicht (kg)	88	88	162	162	236	330	568
Totale hoogte (mm)	773	773	932	932	1016	1112	1288
Diameter minimum (mm)	-	47.90	53.70	-	67.50	77.50	81.50
Machine-apparatuur	☺☺	☺☺	☺☺	☺☺	☺☺	☺☺	☺☺

Machine compatibiliteit							
All-Tach® Narrow	N51502209	-	-	N51502210	-	-	-
All-Tach®	-	N51502209	N51502210	-	N51502211	N51502212	N51502214
850 R	X	X	-	-	-	-	-
1050 R	X	X	X	X	-	-	-
1050 RT	X	-	-	X	-	-	-
1350 R NXT2	X	X	X	X	-	-	-
1350 RT	X	-	-	X	-	-	-
1640 E	X	-	-	-	-	-	-
1650 R	-	-	X	X	X	-	-
1650 RT	-	-	-	X	X	-	-
1850 RT	-	-	-	-	X	X	-
1900 R	-	-	X	X	X	-	-
2150 RT	-	-	-	-	X	X	-
2200 R	-	-	-	-	X	X	-
2600 R	-	-	-	-	X	X	-
2700 V NXT:2	-	-	-	-	X	X	-
3300 V NXT:2	-	-	-	-	X	X	-
4200 V	-	-	-	-	-	X	X
R105	X	-	-	X	-	-	-
R165	-	-	-	X	X	-	-
R190	-	-	-	X	X	-	-
R220	-	-	-	-	X	X	-
R260	-	-	-	-	X	X	-
RT105	X	-	-	X	-	-	-
RT135	X	-	-	X	-	-	-
RT165	-	-	-	X	X	-	-
RT185	-	-	-	-	X	X	-
RT215	-	-	-	-	X	X	-
V270	-	-	-	-	X	X	-
V330	-	-	-	-	X	X	-

SNOW REMOVING SOLUTIONS

Bereik



233 Sneeuwblazer (compacte machines)

235 Sneeuwschuiver (compacte machines)



SNEEUWBLAZER (COMPACTE MACHINES)

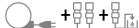

- 2-traps turbine voor een hogere sneuwafvoerefficiëntie.
- Mechanische afstelling van de positie van de afvoergoot.
- Doeltreffend sneeuwruimen en perfecte reiniging van de oppervlakte in één werkgang.

	SBL 1800	SBL 2100
Gewicht (kg)	480	540
Totale hoogte (mm)	1500	2100
Breedte (mm)	1800	2100
Diameter 1 (mm)	450	450
Diameter 2 (mm)	420	420
Machine-apparatuur		





Machine compatibiliteit		
All-Tach®	N51502228	N51502229
1650 R	X	-
1650 RT	X	-
1850 RT	X	-
1900 R	X	-
2100V	X	X
2100VT	X	X
2150 RT	-	X
2200 R	-	X
2300V	X	X
2300VT	X	X
2600 R	-	X
2700 V NXT:2	X	-
2750V	X	X
2750VT	X	X
3300 V NXT:2	-	X
4200 V	-	X
R165	X	-
R190	X	-
R220	-	X
R260	-	X
RT165	X	-
RT185	X	-
RT215	-	X
V210 - NEW	X	X
V230 - NEW	X	X
V270	X	-
V275 - NEW	X	X
V330	-	X
VT210 - NEW	X	X
VT230 - NEW	X	X
VT275 - NEW	X	X



SNEEUWSCHUIVER (COMPACTE MACHINES)







- Hydraulische zijverstelling 30°, 2 cilinders.
- Robuuste bouw met demper en automatische horizontale vlakstelling.
- Doeltreffend sneeuwruimen in één werkgang.

	BLS 1500 / 900 (a)	BLS 1500 / 900 (b)	BLS 1650 / 900	BLS 1800	BLS 1800 / 900
Gewicht (kg)	220	220	250	280	280
Totale hoogte (mm)	700	700	700	700	700
Breedte (mm)	1500	1500	1650	1800	1800
Diepte (mm)	900	900	900	900	900
Machine-apparatuur					
Horizontal angle (°)	30.30	30.30	30.30	30.30	30.30
Working width - angled (mm)	1400	1400	1400	1550	1550

Machine compatibiliteit					
All-Tach®	N51502219	N51502220	N51502221	N51502224	N51502224
4 point Carriage	-	-	52741074	N51502222	-
Euro Carriage	-	-	52741072	N51502223	-
850 R	X	-	-	-	-
1050 R	-	X	X	-	-
1050 RT	-	X	X	-	-
1350 R NXT2	-	-	-	-	X
1350 RT	-	-	-	X	-
1640 E	X	-	-	-	-
2100V	-	-	-	X	-
AL230	X	-	-	-	-
AL320	X	-	-	-	-
AL330	X	-	-	-	-
AL420	X	-	-	-	-
AL430	X	-	-	-	-
GCT 3-14	-	-	X	-	-
GCT 3-14 +	-	-	X	-	-
MLA 2-25 H	X	-	-	-	-
MLA 3-25 H	X	-	-	-	-
MLA 3-25 H-C	X	-	-	-	-
MLA 4-50 H	X	-	-	-	-
MLA 4-50 H-C	X	-	-	-	-
R105	-	X	X	-	-
RT105	-	X	X	-	-
RT135	-	-	-	X	-
ULM 412 H	-	-	X	-	-
ULM 412 H	-	-	X	-	-
ULM 415 H	-	-	X	-	-
ULM 415 H	-	-	X	-	-
V210 - NEW	-	-	-	X	-

VERPLICHTE UITRUSTING VAN MACHINES :  + 

	BLS 2100 / 900 (a)	BLS 2100 / 900 (b)	BLS 2400 / 900 (a)	BLS 2700 / 900
Gewicht (kg)	350	350	410	450
Totale hoogte (mm)	700	700	800	800
Breedte (mm)	2100	2100	2400	2700
Diepte (mm)	900	900	900	900
Machine-apparatuur				
Horizontal angle (°)	30.30	30.30	30.30	30.30
Working width - angled (mm)	-	-	-	-

Machine compatibiliteit

All-Tach®	N51502225	N51502226	N51502227	N51502320
4 point Carriage	-	-	-	-
Euro Carriage	-	-	-	-
1650 R	X	-	-	-
1650 RT	X	-	-	-
1850 RT	-	X	-	-
1900 R	X	-	-	-
2100V	X	-	-	-
2100VT	-	X	-	-
2150 RT	-	-	X	-
2200 R	X	-	-	-
2300V	X	-	-	-
2300VT	-	-	X	-
2600 R	-	-	X	-
2700 V NXT:2	X	-	-	-
2750V	X	-	X	-
2750VT	-	-	X	-
3300 V NXT:2	-	-	X	-
4200 V	-	-	-	X
R165	X	-	-	-
R190	X	-	-	-
R220	X	-	-	-
R260	-	-	X	-
RT165	X	-	-	-
RT185	-	X	-	-
RT215	-	-	X	-
V210 - NEW	X	-	-	-
V230 - NEW	X	-	-	-
V270	X	-	-	-
V275 - NEW	X	-	X	-
V330	-	-	X	-
VT210 - NEW	-	X	-	-
VT230 - NEW	-	-	X	-
VT275 - NEW	-	-	X	-

VERPLICHTE UITRUSTING VAN MACHINES :  + 

LEVELLING SOLUTIONS

Bereik



240 Hydr. Dozer blad (compacte machines)





243 Manueel Dozer blad (compacte machines)



HYDR. DOZER BLAD (COMPACTE MACHINES)







- Hydraulische zijverstelling, traploos en gebruiksvriendelijk (2 cilinders).
- Vastgebouten slijtstukken.
- Voor alle toepassingen om materialen te duwen.

	BLD 1080 H	BLD 1480 H	BLD 1800 H (a)	BLD 1800 H (b)	BLD 1800 H (c)
Gewicht (kg)	195	230	270	270	305
Totale hoogte (mm)	977	677	677	677	677
Breedte (mm)	1080	1480	1800	1800	1800
Diepte (mm)	813	813	813	813	813
Machine-apparatuur					
Horizontal angle (°)	18	18	18	18	18

Machine compatibiliteit					
All-Tach®	N726033	N736037	N757043	N51502490	N51502491
850 R	X	-	-	-	-
1050 R	-	X	-	-	-
1050 RT	-	X	-	-	-
1350 R NXT2	-	X	-	-	-
1350 RT	-	X	-	-	-
1640 E	X	-	-	-	-
1650 R	-	-	X	-	-
1650 RT	-	-	X	-	-
1900 R	-	-	-	X	-
2100V	-	-	-	X	-
2200 R	-	-	-	X	-
2300V	-	-	-	X	-
2600 R	-	-	-	-	X
2750V	-	-	-	-	X
R105	-	X	-	-	-
R135	-	X	-	-	-
R165	-	-	X	-	-
R190	-	-	-	X	-
R220	-	-	-	X	-
R260	-	-	-	-	X
RT105	-	X	-	-	-
RT135	-	X	-	-	-
RT165	-	-	X	-	-
V210 - NEW	-	-	-	X	-
V230 - NEW	-	-	-	X	-
V275 - NEW	-	-	-	-	X

VERPLICHTE UITRUSTING VAN MACHINES : 

	BLD 2000 H (a)	BLD 2000 H (b)	BLD 2135 H	BLD 2365 H
Gewicht (kg)	305	305	470	510
Totale hoogte (mm)	677	677	677	677
Breedte (mm)	2000	2000	2135	2365
Diepte (mm)	813	813	813	933
Machine-apparatuur				
Horizontal angle (°)	18	18	30	30

Machine compatibiliteit				
All-Tach®	N757044	N51502492	N51502085	N700264
2300VT	-	-	X	-
2600 R	-	X	-	-
2700 V NXT:2	X	-	-	-
2750V	-	X	-	-
2750VT	-	-	X	-
3300 V NXT:2	-	-	X	-
4200 V	-	-	-	X
R260	-	X	-	-
V270	X	-	-	-
V275 - NEW	-	X	-	-
V330	-	-	X	-
VT230 - NEW	-	-	X	-
VT275 - NEW	-	-	X	-

VERPLICHTE UITRUSTING VAN MACHINES : 



MANUEEL DOZER BLAD (COMPACTE MACHINES)



- Zijverstelling : mechanisch of hydraulisch (2 cilinders).
- Vastgeboute slijtstukken.
- Voor alle toepassingen om materialen te duwen.

	BLD 1080	BLD 1480	BLD 1800 (a)	BLD 1800 (b)	BLD 2000 (a)	BLD 2000 (b)
Gewicht (kg)	135	185	205	205	288	288
Totale hoogte (mm)	677	677	677	677	677	677
Breedte (mm)	1080	1480	1800	1800	2000	2000
Diepte (mm)	813	813	813	813	813	813
Machine-apparatuur	×	×	×	×	×	×
Horizontal angle (°)	30	30	30	30	30	30

Machine compatibiliteit						
All-Tach®	N726032	N736036	N51502488	N757041	N51502489	N757042
850 R	X	-	-	-	-	-
1050 R	-	X	-	-	-	-
1050 RT	-	X	-	-	-	-
1350 R NXT2	-	X	-	-	-	-
1350 RT	-	X	-	-	-	-
1640 E	X	-	-	-	-	-
1650 R	-	-	X	-	-	-
1650 RT	-	-	-	X	-	-
1900 R	-	-	-	X	-	-
2100V	-	-	-	X	-	-
2200 R	-	-	-	X	-	-
2300V	-	-	-	X	-	-
2600 R	-	-	-	X	-	X
2700 V NXT:2	-	-	-	-	X	-
2750V	-	-	-	-	X	-
R105	-	X	-	-	-	-
R135	-	X	-	-	-	-
R165	-	-	X	-	-	-
R190	-	-	-	X	-	-
R220	-	-	-	X	-	-
R260	-	-	-	X	-	X
RT105	-	X	-	-	-	-
RT135	-	X	-	-	-	-
RT165	-	-	-	X	-	-
V210 - NEW	-	-	-	X	-	-
V230 - NEW	-	-	-	X	-	-
V270	-	-	-	-	X	-
V275 - NEW	-	-	-	-	X	-

DIVERSE VOORZETSTUKKEN

Bereik



247 Mand materialen **NEW**



NEW

MAND MATERIALEN



- 1.2m reach and 1000kg capacity.
- Transport and storage facilitated by its foldability.
- Efficient and inexpensive solution for the safe movement of materials in all types of application, environment and meteorology.
- Front opening facilitating pallet loading.



	MB 2000 / 1000
Capaciteit (kg)	1000
Gewicht (kg)	400
Totale hoogte (mm)	1215
Totale lengte (mm)	1632
Breedte (mm)	2056
Diepte (mm)	1120
Machine-apparatuur	×

Machine compatibiliteit	
Referentienummer	52596600
MLT 630-115	X
MLT 630-115 V	X
MLT 630-115 V CP	X
MLT 635-130 PS+	X
MLT 635-140 V+	X
MLT 730-115 V	X
MLT 730-115 V CP	X
MLT 733-115	X
MLT 733-115 LSU	X
MLT 737-130 PS+	X
MLT 741-130 PS+	X
MLT 741-140 V+	X
MLT 841-145 PS+	X
MLT 850-145 V+	X
MLT 940-140 V+	X
MLT 1041-145 PS+L	X
MLT-X 625-75 H	X
MLT-X 737-130 PS+	X
MLT-X 741-140 V+	X
MLT-X 741 T LSU	X
MLT-X 841 - 145 PS+	X
MLT-X 850-145 V+	X
MLT-X 1041-145 PS+L	X
MT 625 e	X
MT 625 HA	X
MT 730 H	X
MT 733 Easy	X
MT 735 75D ST5	X
MT 930 H	X
MT 930 HA	X
MT 933 Easy	X
MT 935 75D ST5	X
MT 1033 easy	X
MT 1135 75 D	X
MT 1135 H 100D	X
MT 1135 easy ST5	X

MB 2000 / 1000

Machine compatibiliteit	
MT 1135 H easy ST5	X
MT 1135 HA Easy ST5	X
MT 1135 ST5	X
MT 1335 75D ST5	X
MT 1335 100D ST5	X
MT 1335	X
MT 1335 easy ST5	X
MT 1335 H 75D ST5	X
MT 1335 H 100D ST5	X
MT 1335 H easy ST5	X
MT 1335 HA 75D ST5	X
MT 1335 HA 100D ST5	X
MT 1335 HA easy ST5	X
MT 1335 ST5	X
MT 1440 A ST5	X
MT 1440 easy ST5	X
MT 1440 HA ST5	X
MT 1440 ST5	X
MT 1840 A 100D ST5 S1	X
MT 1840 easy ST5	X
MT 1840 HA	X
MT 1840 ST5	X
MT-X 625 H	X
MT-X 733	X









VERPLICHTE UITRUSTING VAN MACHINES : ✕

MANITOU biedt standaard het voorzetherkenningssysteem aan op zijn nieuwe generatie roterende telescopische trucks MRT.

Het systeem maakt gebruik van de RFID-technologie voor radio-identificatie, die zeer veel wordt gebruikt in de industrie en de kleinhandel. Deze autonome techniek kan op afstand gegevens recupereren en registreren. De machine detecteert het voorzetstuk aan de kop van de giek, analyseert de gegevens en stelt rechtstreeks de overeenkomstige werkconfiguratie voor (werkbereik + bewegingssnelheid + veiligheid).

Deze technologie levert in real time de belastingsgrafiek, rekening houdend met de rotatiehoek van de toren en de positie van de stabilisatoren van de machine en in overeenstemming met de norm voor mobiele kranen.

TABEL VAN SYMBOLEN

	Geen aanleg vereist
	Hydraulische leiding
	Hydraulische retour naar tank
	Elektrische voorbereiding
	Voorpositionering platform
	Voorpositionering bandenlichter, cilinderlichter
	Neem contact op met uw Manitou-dealer (verzoek om speciale oplossing vereist)
	Hangende lading : lees gebruikershandleiding
	Machine equipped with attachment recognition system



Landbouw



Bouw



Industrie

OPMERKING

A series of 20 horizontal dotted lines for writing notes.

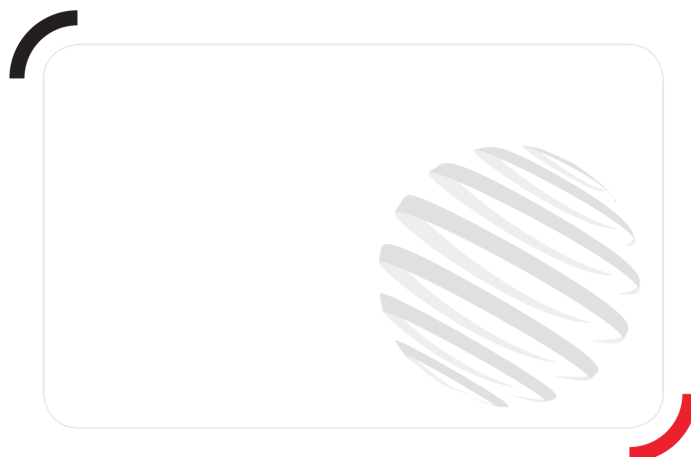

MANITOU ATTACHMENTS

Hoofdkantoor

B.P. 249 - 430 rue de l'Aubinière

44150 Ancenis Cedex - Frankrijk

Tel.: 00 33 (0)2 40 09 10 11 - Fax: 00 33 (0)2 40 09 10 97

www.manitou.com



Deze brochure beschrijft versies en con guratie-opties voor Manitou-producten die met verschillende apparatuur kunnen worden uitgerust. De uitrusting die in deze brochure wordt beschreven, kan standaard, optioneel of niet leverbaar zijn, afhankelijk van de uitvoering. Manitou behoudt zich het recht voor om de weergegeven en beschreven speci caties op elk moment en zonder kennisgeving vooraf te wijzigen. De fabrikant is niet aansprakelijk voor de gegeven speci caties. Neem voor meer informatie contact op met uw Manitou-dealer. Niet-contractueel document. De productbeschrijvingen kunnen afwijken van de werkelijke producten. De lijst met speci caties is niet allesomvattend. De logos en visuele identiteit van het bedrijf zijn eigendom van Manitou en mogen niet zonder toestemming worden gebruikt. Alle rechten voorbehouden. De foto's en diagrammen in deze brochure zijn uitsluitend bedoeld voor raadpleging en informatie.

MANITOU BF SA - Naamloze vennootschap met raad van bestuur - Aande- lenkapitaal: 39.668.399 euro - 857 802 508 RCS Nantes